

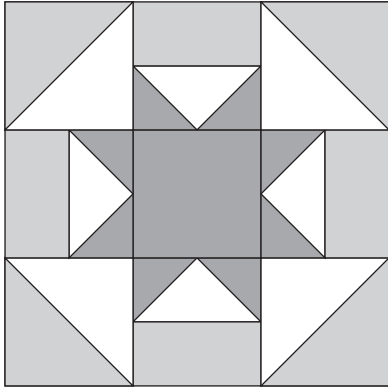

SCAN ME



Keepsake

by Anne Sutton of Bunny Hill Designs

Whenever I think of making a quilt that will be handed down from generation to generation, I include the timeless sawtooth star quilt block. It's a basic block that's easy to get creative with. By just reversing the colors, you can get a dramatic effect! Play around with the corners like I did, and you'll get some wonderful effects.

I've named my block Keepsake because it's a block that's timeless and perfect for a wedding, baby, or a Veteran's Day quilt. Make a Keepsake label for the back of a quilt and autograph the center square.

I hope you enjoy making this block!



@bunnyhilldesigns



bunnyhill.com

Cutting Instructions

Qty	6" finished block	12" finished block
2	3" squares (A)	5" squares (A)
2	3" squares (B)	5" squares (B)
4	2 1/8" squares (C)	3 1/8" squares (C)
1	3 1/2" square (D)	5 1/2" squares (D)
4	1 1/2" x 2 1/2" rectangles (E)	2 1/2" x 4 1/2" rectangles (E)
1	2 1/2" square (F)	4 1/2" squares (F)

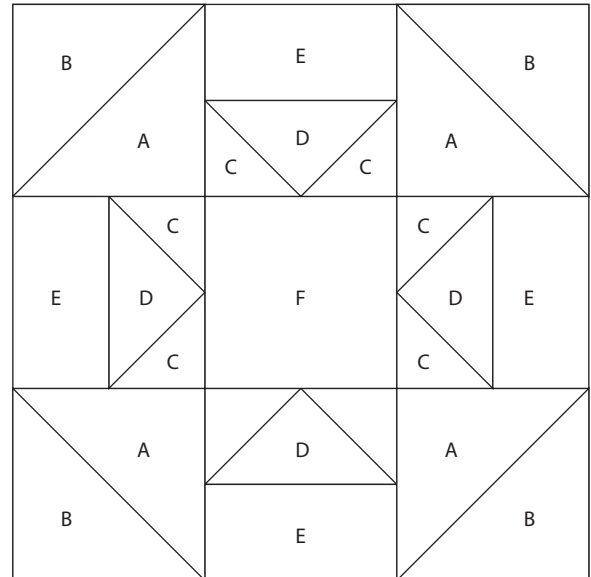

Use this block to plan color and fabric placement!

My Swatches

A B C D E F





Piecing Instructions

Step 1

On the wrong side of each A square, draw a line from one corner to the opposing corner as shown.

Place A and B squares right sides together. Stitch a scant $\frac{1}{4}$ " seam on both sides of the drawn line. Cut the square apart on the line to yield two HSTs, and press the seams to the darker triangles (B).

Repeat to make 4 A/B HSTs. Trim HSTs to $2\frac{1}{2}$ " (6" block) or $4\frac{1}{2}$ " (12" block).

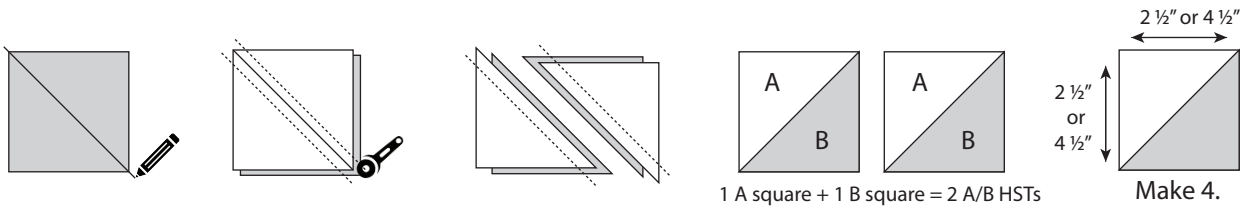

Step 2

On the wrong side of each C square, draw a line from one corner to the opposing corner as shown.

With right sides together, align 2 C squares in opposite corners of the D square as shown.

Stitch a scant $\frac{1}{4}$ " seam on both sides of the drawn line. Cut the square apart on the line to yield 2 partial flying geese units, and press the seams to the C triangles.

With right sides together, align another C square in the corner of the D triangle as shown.

Stitch a scant $\frac{1}{4}$ " seam on both sides of the drawn line. Cut the square apart on the line to yield 2 complete flying geese units, and press the seams to the C triangles.

Repeat to make 4 C/D flying geese units. Trim to $1\frac{1}{2}$ " x $2\frac{1}{2}$ " (6" block) or $2\frac{1}{2}$ " x $4\frac{1}{2}$ " (12" block).

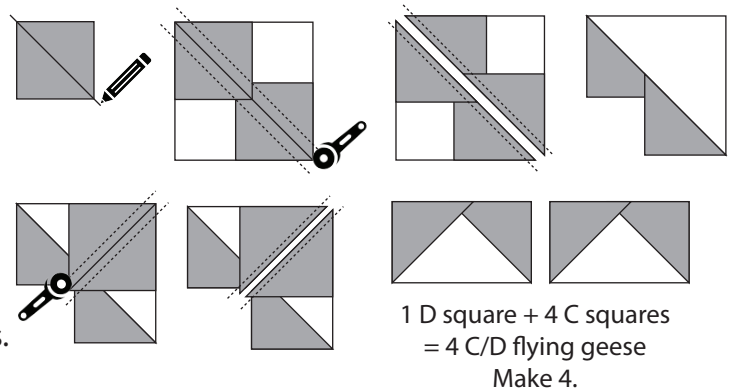

Get to know Anne...

I know the stars have aligned when...
*I suddenly have a whole day to sew,
and dinner gets delivered.*

I'd be totally star-struck if I could meet...
Martha Stewart, of course!

If I could wish on a star, I'd wish for...
*enough money to fund the perfect
animal rescue and fostering program.*

Star Trek, Star Wars, or Dancing With the Stars?
Dancing with the stars! My granddaughter is studying dance at San Diego State.

I thank my lucky stars that...
I'm a Moda Designer!





SCAN ME

Piecing Instructions, continued

Step 3

Lay out 1 C/D flying geese and 1 E rectangle as shown.
 Sew together to make a flying geese unit.
 Press seam towards the E rectangle.

Repeat to make 4 flying geese units measuring
 2 1/2" (6" block) or 4 1/2" (12" block).

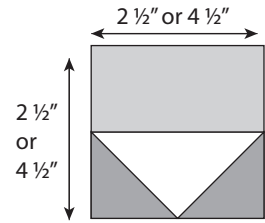
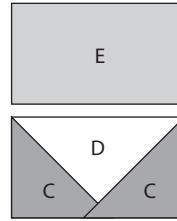

Make 4.

Step 4

Lay out A/B HSTs, flying geese units,
 and the F square as shown.

Join units to make the full block.
 Trim to 6 1/2" or 12 1/2".

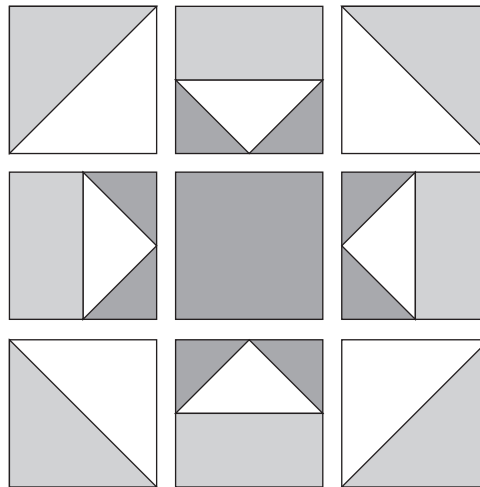



Additional Coloring Blocks

