

Sparkle
by Crystal Manning

For me, all of these beautiful star blocks represent the connection that we have and that's the love of quilting and the desire to be creative. So add a little Sparkle to your collection of blocks this week. Enjoy!



Cutting Instructions

Qty	6" finished block	12" finished block
16	1" squares (A)	1 1/2" squares (A)
16	1" squares (B)	1 1/2" squares (B)
8	1 1/2" squares (C)	2 1/2" squares (C)
1	3 1/2" square (D)	5 1/2" square (D)
4	2 1/8" squares (E)	3 1/8" squares (E)
4	2 1/2" x 1 1/2" rectangles (F)	4 1/2" x 2 1/2" rectangles (F)
2	2" squares (G)	3" squares (G)
1	2" square (H)	3" square (H)
1	2" square (I)	3" square (I)

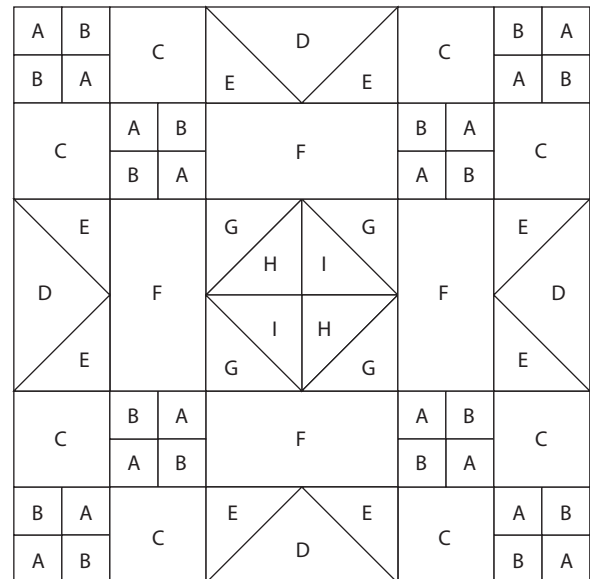

Use this block to plan color and fabric placement!

My Swatches

A B C D E F

G H I





Piecing Instructions

Step 1

Lay out 2 A squares and 2 B squares as shown. Sew together to make a checkerboard four-patch unit.

Repeat to make 8 A/B four-patch units measuring 1 1/2" (6" block) or 2 1/2" (12" block).

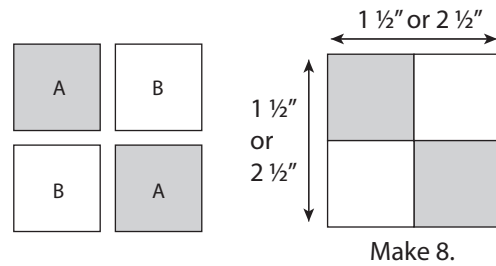

Make 8.

Step 2

Lay out 2 A/B four-patch units and 2 C squares as shown. Sew together to make an A/B/C corner unit.

Repeat to make 4 corner units measuring 2 1/2" (6" block) or 4 1/2" (12" block).

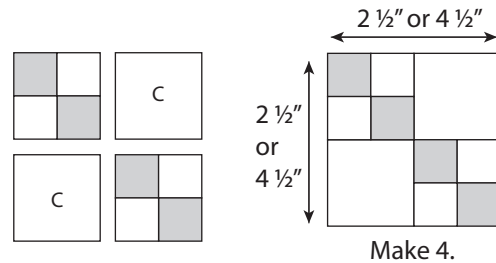

Make 4.

Step 3

On the wrong side of each E square, draw a line from one corner to the opposing corner as shown.

With right sides together, align 2 E squares in opposite corners of the D square as shown.

Stitch a scant 1/4" seam on both sides of the drawn line. Cut the square apart on the line to yield 2 partial flying geese units, and press the seams to the E triangles.

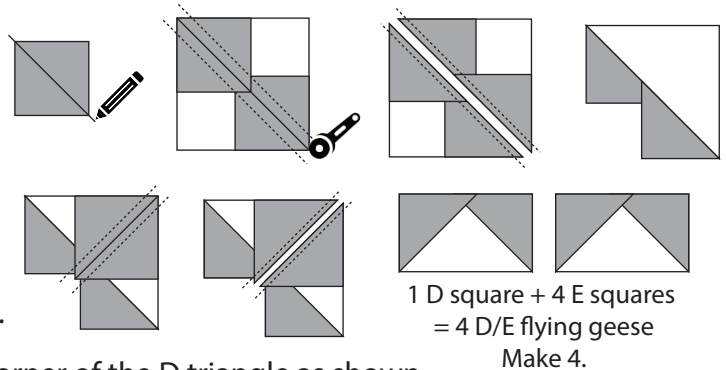

1 D square + 4 E squares
= 4 D/E flying geese
Make 4.

With right sides together, align another E square in the corner of the D triangle as shown.

Stitch a scant 1/4" seam on both sides of the drawn line. Cut the square apart on the line to yield 2 complete flying geese units, and press the seams to the E triangles.

Repeat to make 4 D/E flying geese units. Trim to 1 1/2" x 2 1/2" (6" block) or 2 1/2" x 4 1/2" (12" block).

Get to know Crystal...

- I know the stars have aligned when...
I walk into a store and they have fabric on sale.
- Star Trek, Star Wars, or Dancing With the Stars?
Star Wars. My husband sounds like Chewie when he yawns.
- If I could wish on a star, I'd wish for...
An assistant to cut my fabric and clean my sewing space.
- I thank my lucky stars that...
I'm a designer for Moda and part of this creative community.





SCAN ME

Piecing Instructions, continued

Step 4

Lay out 1 D/E flying geese and 1 F rectangle as shown. Sew together to make a flying geese unit. Press seam open.

Repeat to make 4 flying geese units measuring 2 1/2" (6" block) or 4 1/2" (12" block).

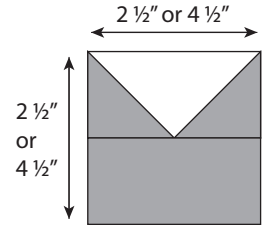
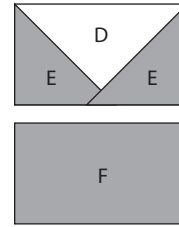

Make 4.

Step 5

On the wrong side of each G square, draw a line from one corner to the opposing corner as shown.

Place G and H squares right sides together. Stitch a scant 1/4" seam on both sides of the drawn line. Cut the square apart on the line to yield 2 HSTs, and press the seams to the darker triangles (G).

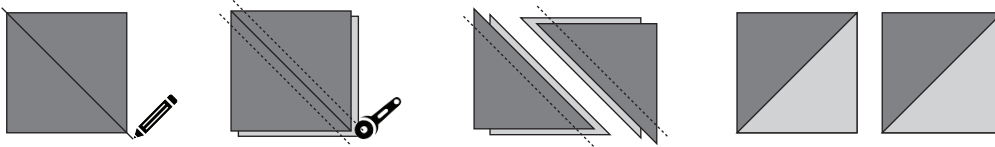

1 G square + 1 H square = 2 G/H HSTs

Repeat to make 2 G/H HSTs and 2 G/I HSTs.

Trim all HSTs to 1 1/2" (6" block) or 2 1/2" (12" block).

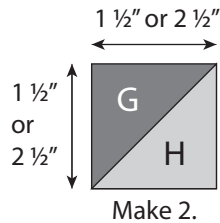

Make 2.

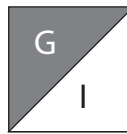

Make 2.

Step 6

Lay out G/H and G/I HSTs as shown.

Join HSTs to make a center unit measuring 2 1/2" (6" block) or 4 1/2" (12" block).

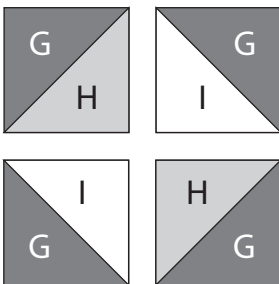

Step 7

Lay out corner units, flying geese units, and square-in-a-square unit as shown.

Join units to make the full block. Trim to 6 1/2" or 12 1/2".

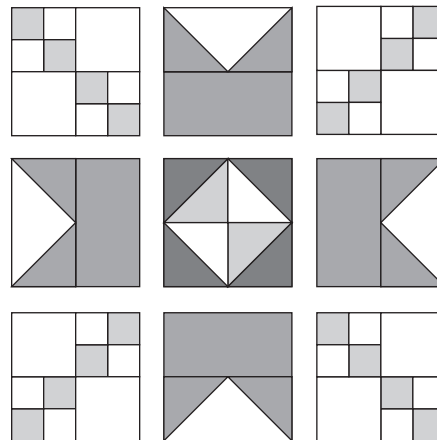



Additional Coloring Blocks

