

Gemstones

Quilt Design by Cyndi Hershey

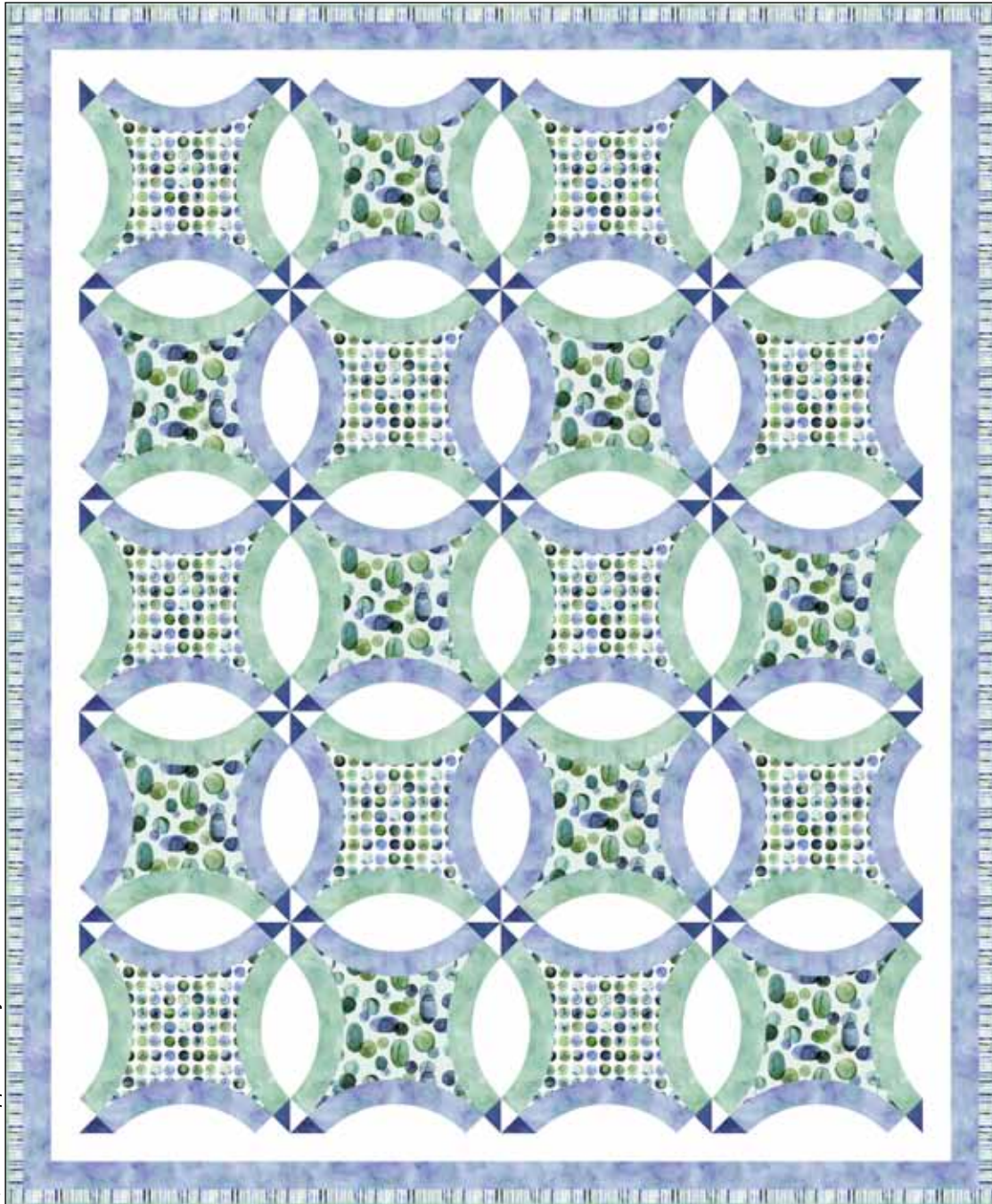

Quilt size: approximately 70" x 85"

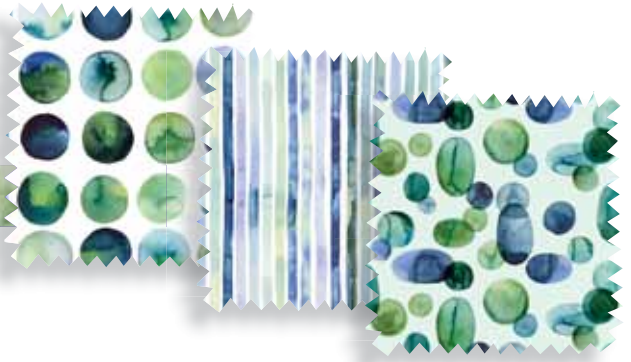

Featuring fabrics from
Gemstones by Stephanie Ryan

P&B Textiles • pbtex.com • 800-351-9087 • 208 Clock Tower Square, Portsmouth, RI 02871

Gemstones

Fabric collection by Stephanie Ryan

Quilt designed by Cyndi Hershey

Skill level: Intermediate Plus • Finished Quilt Size: approximately 70" x 85"

Quilt Yardages:

Fabric A:	GEMS 5220 BG	1 5/8 yards
Fabric B:	GEMS 5223 BG	1 5/8 yards
Fabric C:	GEMS 5225 BG	1/2 yard
Fabric D:	CSTO 5226 DB	3/8 yard
Fabric E:	CSTO 5226 LB	3 yards
Fabric F:	CSTO 5226 LT	3 yards
Fabric G:	RA13 4883 W	3 1/8 yards
Backing:	GEMS 5222 BG suggested	5 1/4 yards
Batting		78" x 93"

Additional supplies: template plastic, freezer paper or other material to make templates.

Cutting Instructions:

All strips are cut across the width of the fabric (perpendicular to selvages) unless noted otherwise. All seams are 1/4". Prepare templates using the masters that are provided.

Note: This is a Double Wedding Ring quilt but has an easier method of construction. This quilt is created using 15" finished square blocks to make assembly easier.

Note: You may find it helpful to make one "test" unit before you begin on the quilt blocks. Doing so can help give you understanding of the construction process.

From Fabric A:

1. Cut ten block centers using Template 1. (Blocks)

From Fabric B:

1. Cut ten block centers using Template 1. (Blocks)

From Fabric C:

1. Cut eight 1 1/2" strips. Sew strips together end to end with diagonal seams. Trim seams and press open. From this pieced strip, cut two 1 1/2" x 70 1/2" strips and two 1 1/2" x 83 1/2" strips. (Outer Border)

From Fabric D:

1. Cut two 3 3/4" strips; subcut twenty 3 3/4" squares. Cut each square diagonally in both directions to yield eighty quarter-square triangles. (Blocks)

From Fabric E:

1. Cut five 14" strips. Cut forty arcs using Template 2. You should be able to cut eight shapes per strip. (Blocks)
2. Cut eight 2 1/2" strips. Sew strips together end to end with diagonal seams. Trim seams and press open. From this pieced strip, cut two 2 1/2" x 68 1/2" strips and two 2 1/2" x 79 1/2" strips. (2nd Border)

From Fabric F:

1. Cut five 14" strips. Cut forty arcs using Template 2. You should be able to cut eight shapes per strip. (Blocks)
2. Cut nine 2 1/2" strips. (Binding)

From Fabric G:

1. Cut seven 11" strips. Cut eighty shapes (half-melons) using Template 3. You should be able to cut thirteen shapes per strip. (Blocks)
2. Cut two 3 3/4" strips; subcut twenty 3 3/4" squares. Cut each square diagonally in both directions to yield eighty quarter-square triangles. (Blocks)
3. Cut eight 2 1/2" strips. Sew strips together end to end with diagonal seams. Trim seams and press open. From this pieced strip, cut two 2 1/2" x 64 1/2" strips and two 2 1/2" x 75 1/2" strips. (Inner Border)

Piecing Instructions:

1. Sew one Template 3/G half-melon to one Template 2/E arc. Begin by matching the centers of both shapes and pinning, taking a tiny "bite" of fabric. Then, match the seam points at both ends of the two shapes and pin. Sew seam. Some sewers prefer a slightly shorter stitch to help maneuver the curve. Press toward G.
2. Sew one D triangle to the right end of the Step 1 unit. Press open. Sew one G triangle to the left end of the unit. Press open. Repeat to make forty units. (Figure 1)



Figure 1 Make 40.

3. Repeat Steps 1 and 2 using Template 2/F arcs with Template 3/G half-melons. (Figure 2)

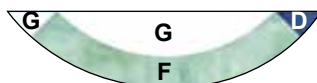

Figure 2 Make 40.

4. Sew one E/G unit to both sides of one Template 1/A block center, matching seam points. Press toward the E/G unit. Sew one F/G unit to the remaining two sides of the center; press. Repeat to make ten blocks. (Figure 3)



Figure 3 Make 10.
15 1/2" square unfinished.

5. Repeat Step 4 using Template 1/B block centers. (Figure 4)

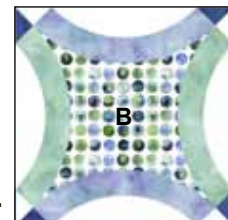
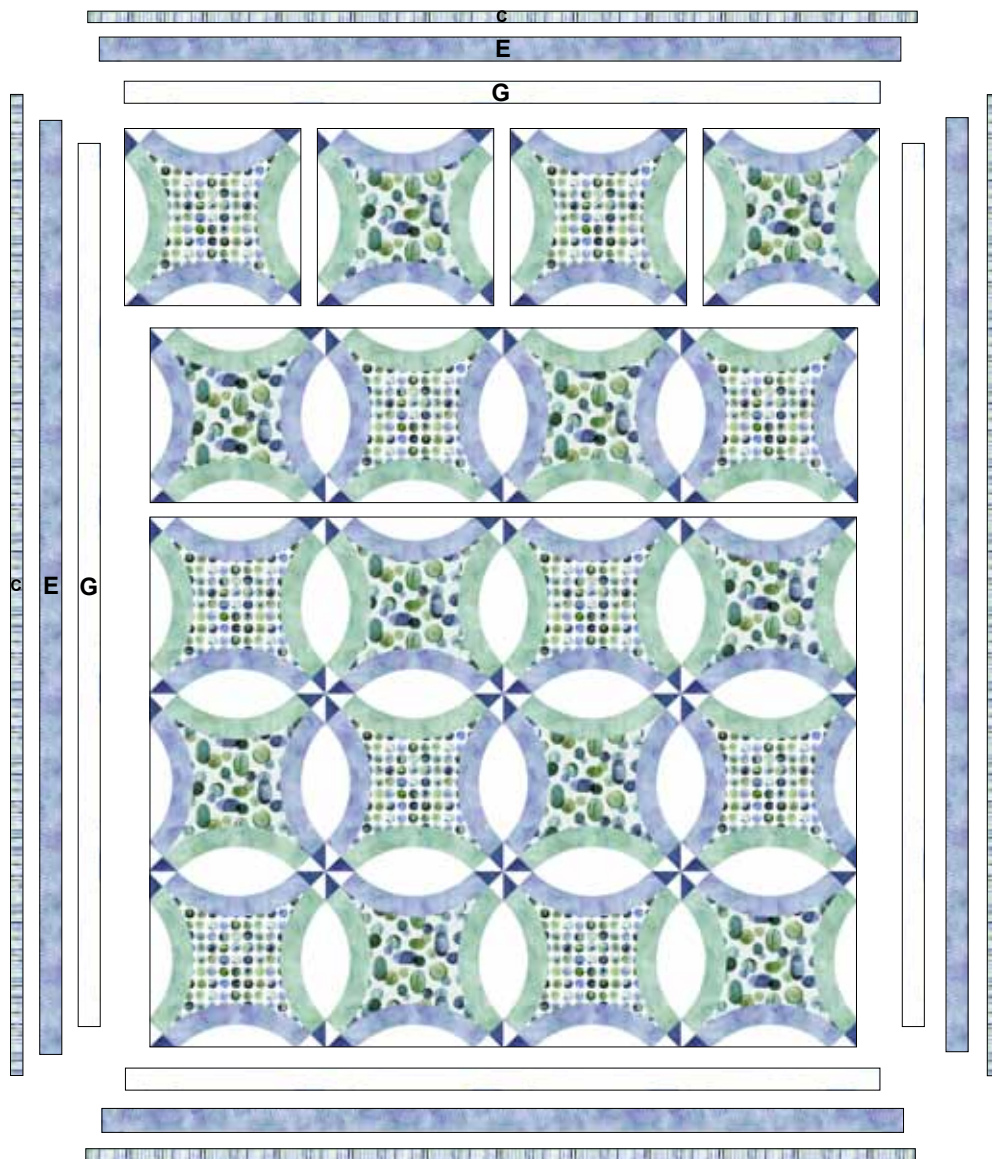

Figure 4 Make 10.
15 1/2" square unfinished.

6. Refer to Quilt Diagram to lay blocks into rows alternating the two blocks. Be sure to rotate blocks so that the E and F arcs connect visually to create "rings". Sew blocks into rows and press seams open.
7. Sew rows together and press seams open.
8. Sew one 2 1/2" x 75 1/2" G strip to both sides of Quilt Center. Press toward G. Sew one 2 1/2" x 64 1/2" G strip to the top and bottom of the Quilt Center; press.
9. Sew one 2 1/2" x 79 1/2" E strip to both sides of the quilt. Press toward F. Sew one 2 1/2" x 68 1/2" E strip to the top and bottom of the quilt; press.
10. Sew one 1 1/2" x 83 1/2" C strip to both sides of the quilt. Press toward C. Sew one 1 1/2" x 70 1/2" C strip to the top and bottom of the quilt; press.

Finishing:

1. Prepare backing using two widths. Press seams open and trim to 78" x 93".
2. Layer quilt, batting, and backing. Baste layers together.
3. Quilt as desired.
4. Trim layers even with quilt top, squaring corners.
5. Join nine 2 1/2" F binding strips with diagonal seams. Press seams open. Attach binding using your favorite method.
6. Make a label and sew to the back of the quilt.



Quilt Diagram

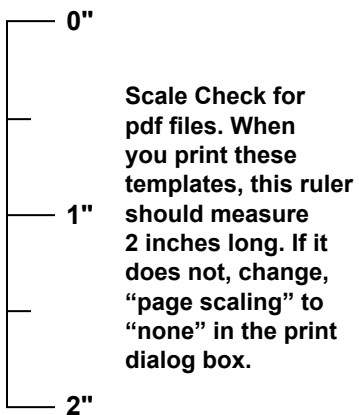
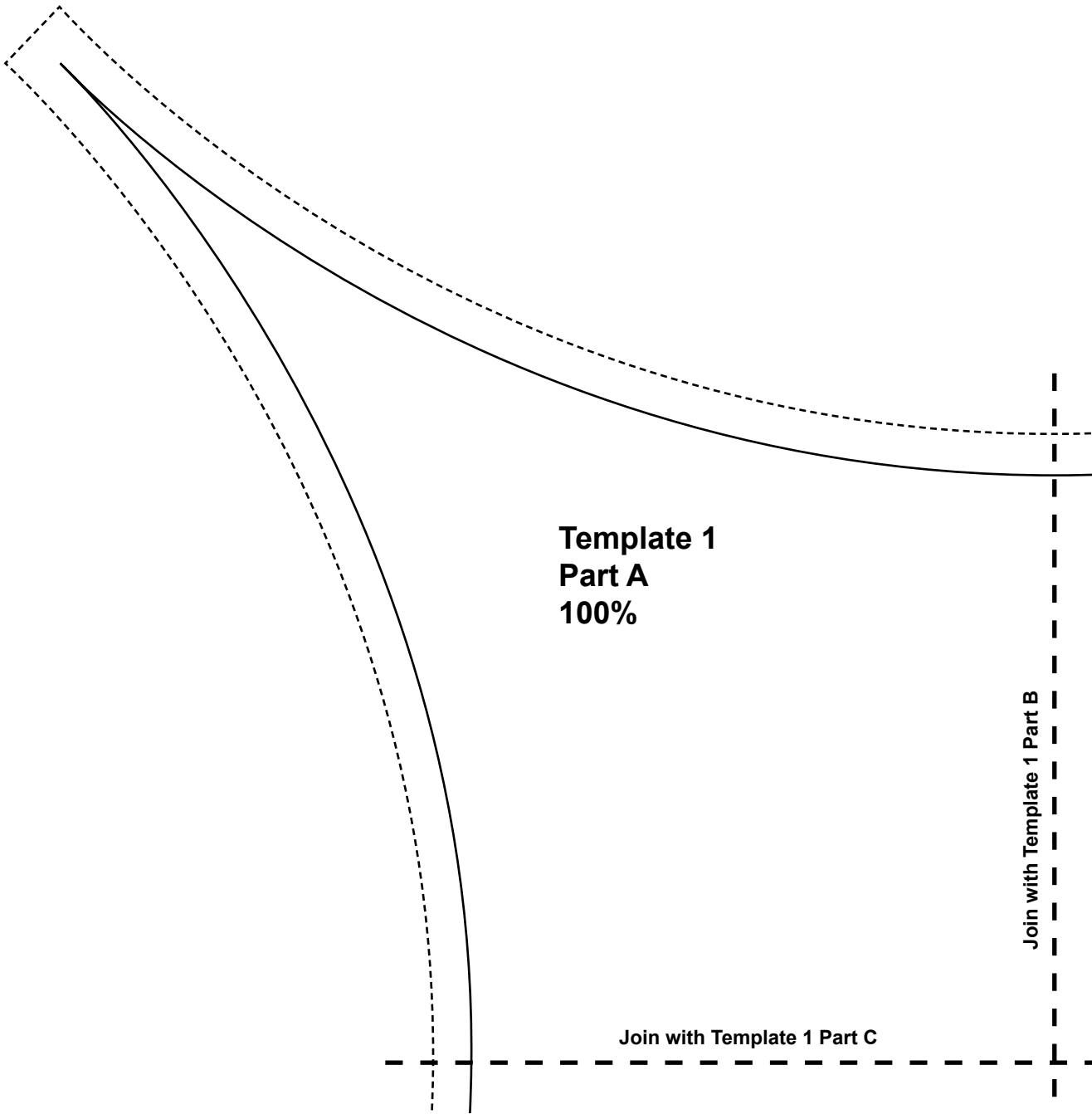

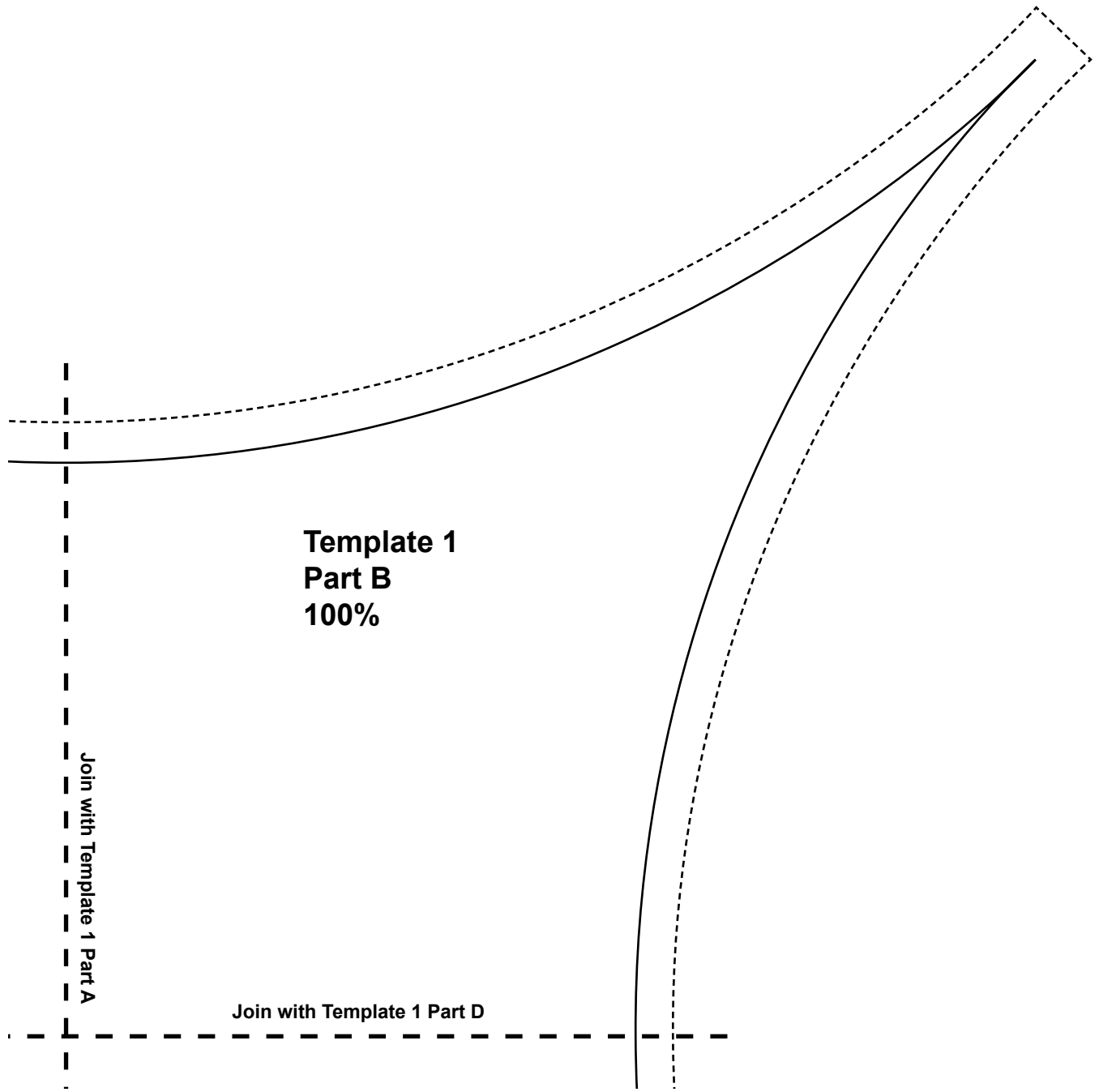

**Template 1
Part B
100%**

Join with Template 1 Part A

Join with Template 1 Part D

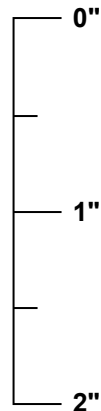

Scale Check for pdf files. When you print these templates, this ruler should measure 2 inches long. If it does not, change, "page scaling" to "none" in the print dialog box.

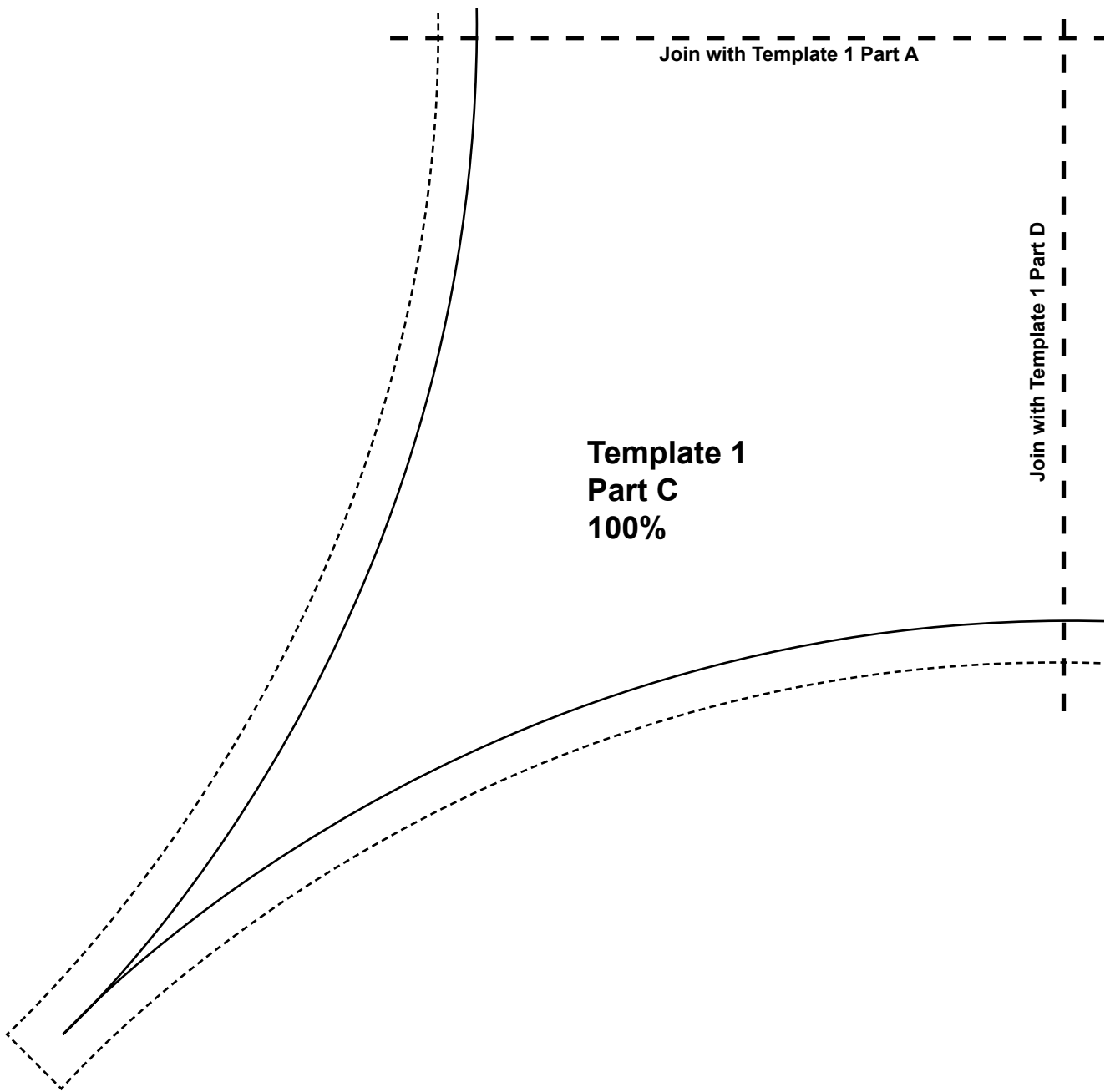

**Template 1
Part C
100%**

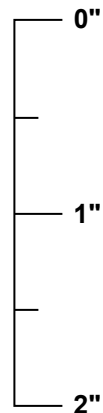

Scale Check for pdf files. When you print these templates, this ruler should measure 2 inches long. If it does not, change, "page scaling" to "none" in the print dialog box.

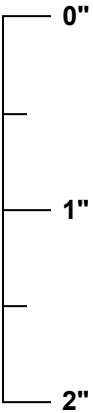
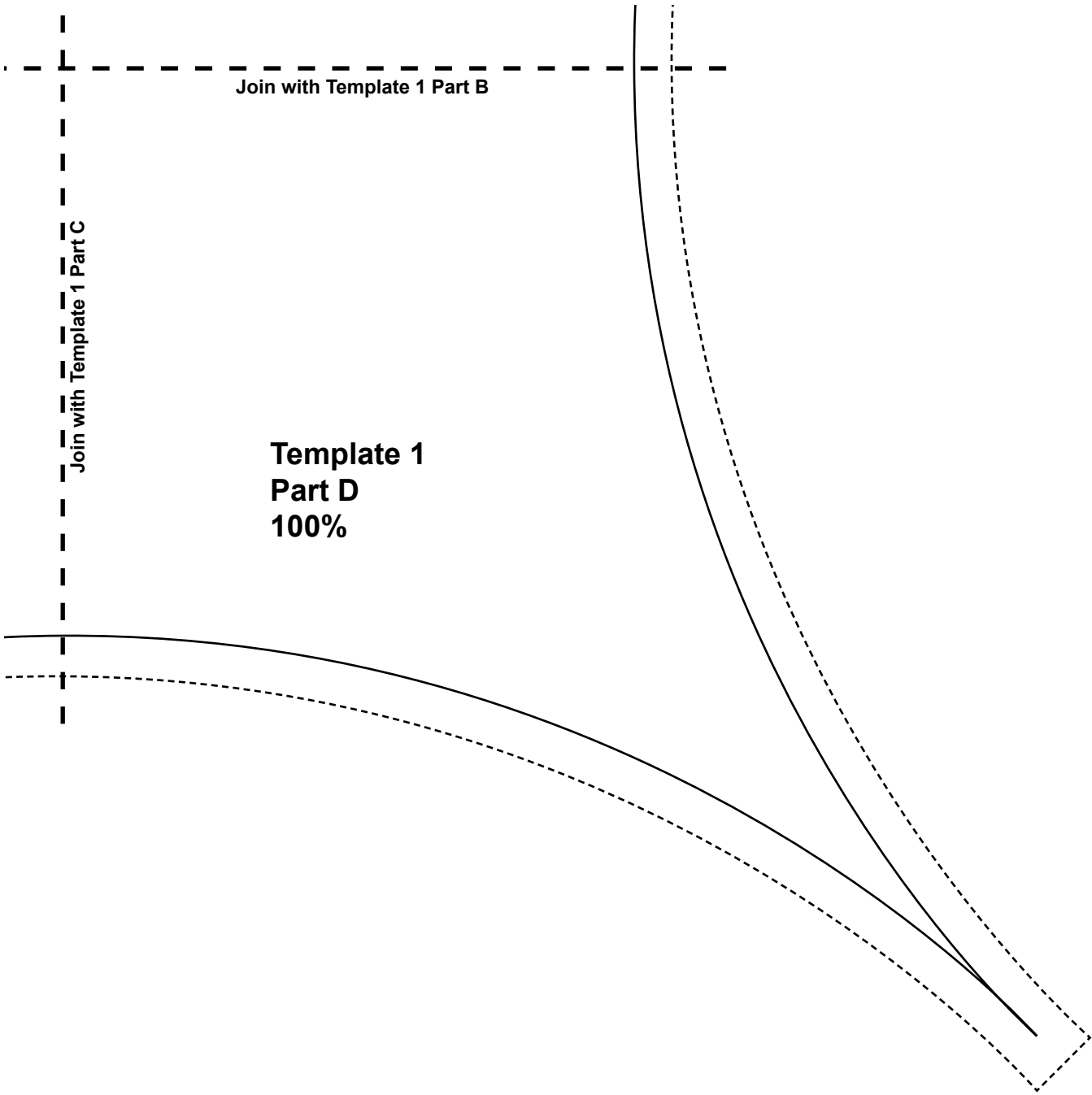

Scale Check for pdf files. When you print these templates, this ruler should measure 2 inches long. If it does not, change, "page scaling" to "none" in the print dialog box.

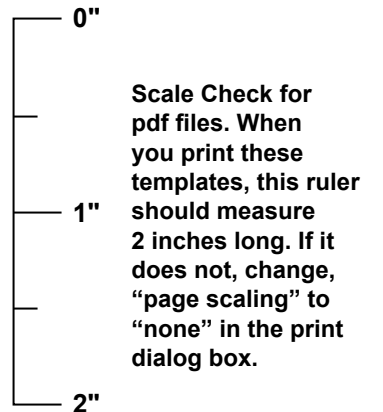
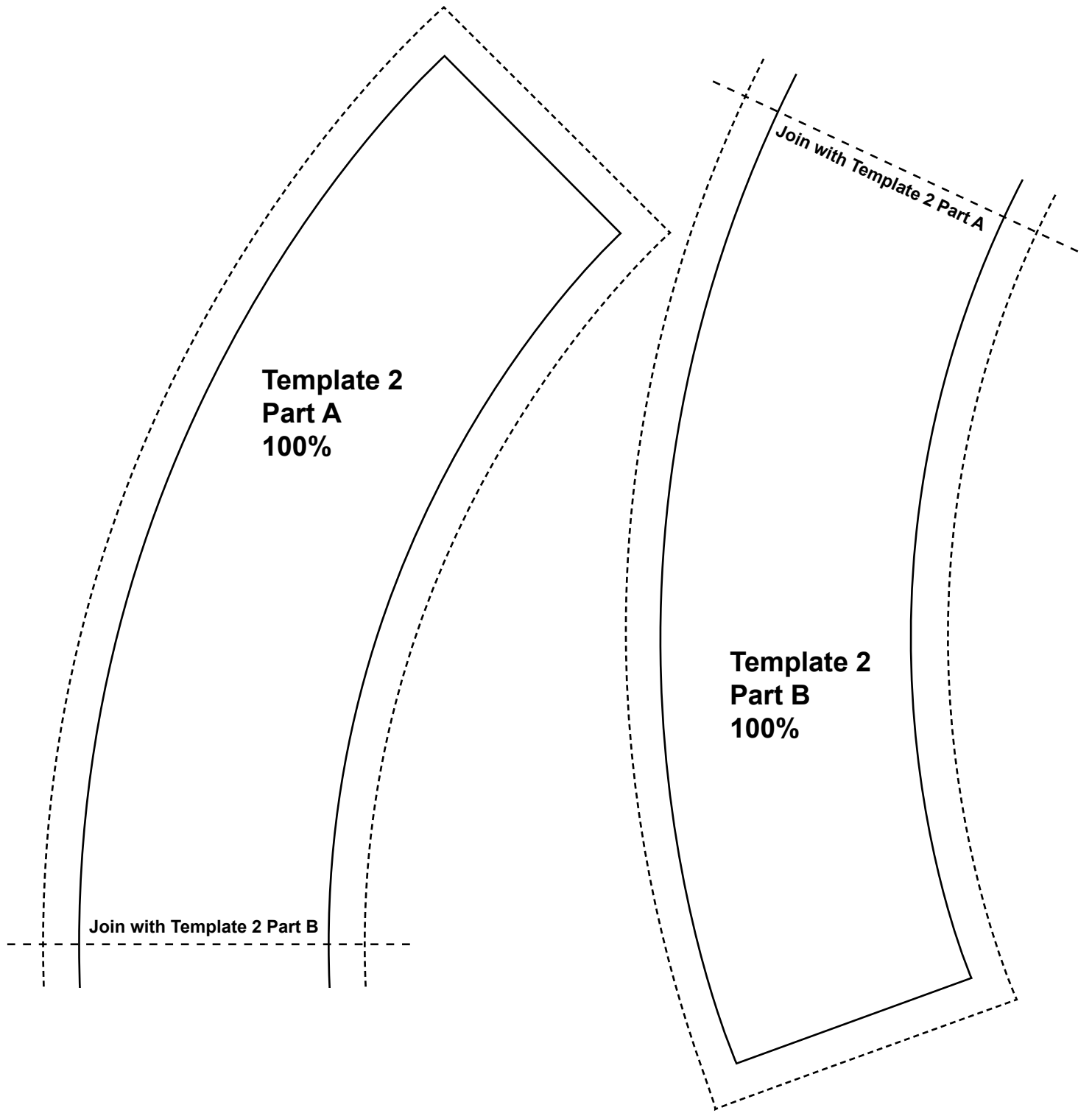

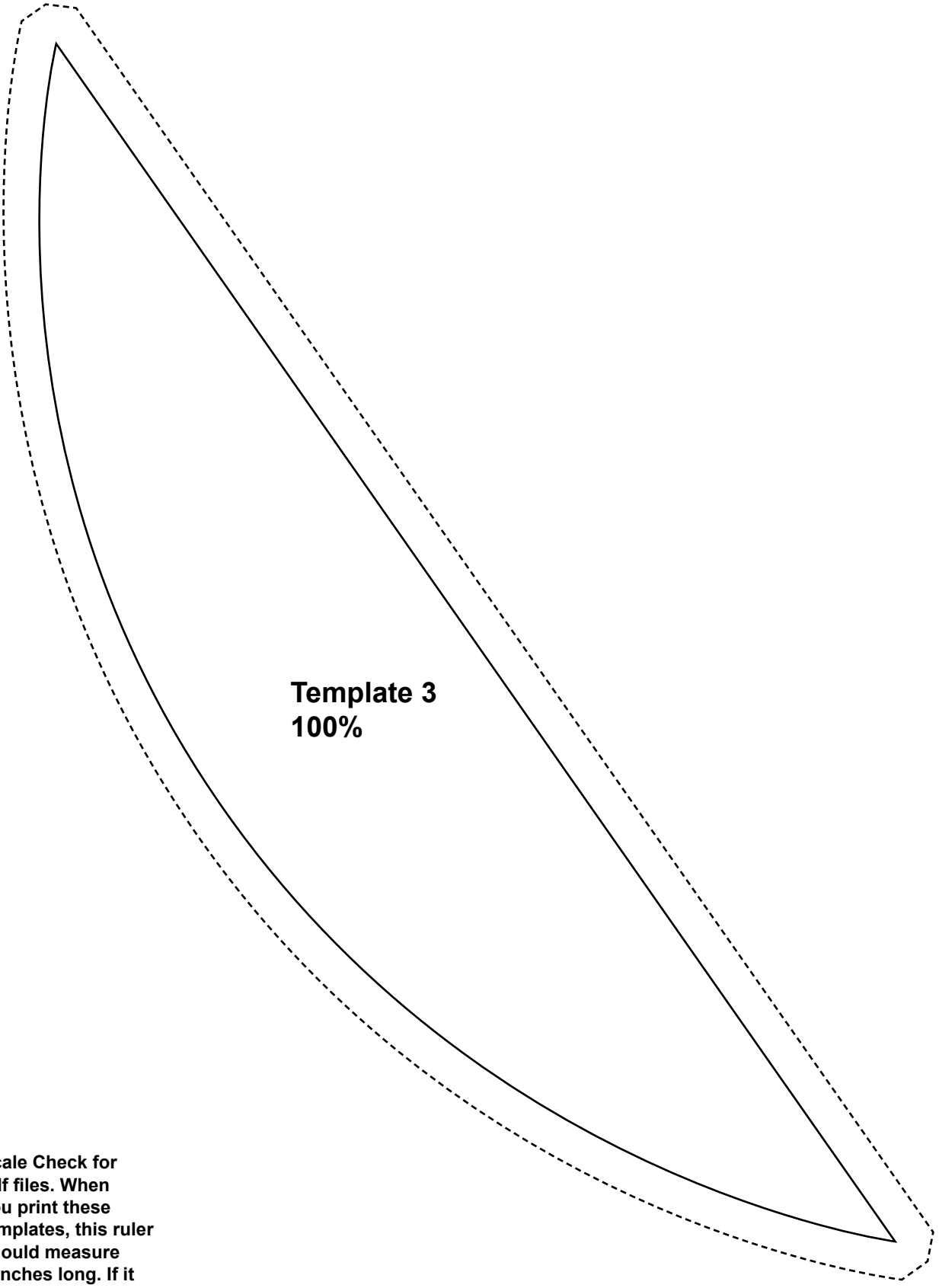

**Template 3
100%**

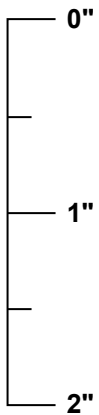

**Scale Check for
pdf files. When
you print these
templates, this ruler
should measure
2 inches long. If it
does not, change,
“page scaling” to
“none” in the print
dialog box.**

Gemstones

Fabric Collection by Stephanie Ryan



GEMS 5219 BG



GEMS 5219 MU



GEMS 5220 BG*



GEMS 5220 MU



GEMS 5221 BG



GEMS 5221 MU

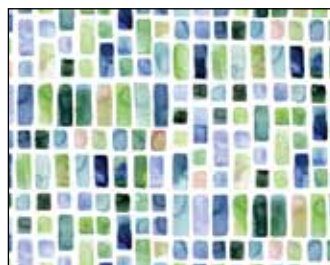

GEMS 5222 BG†



GEMS 5222 MU

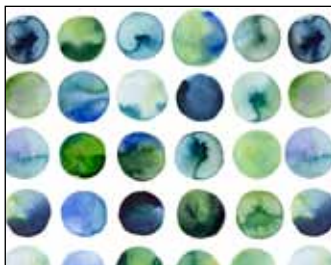

GEMS 5223 BG*

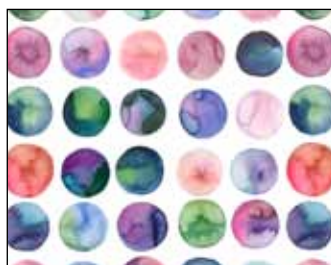

GEMS 5223 MU



GEMS 5224 BG



GEMS 5224 MU

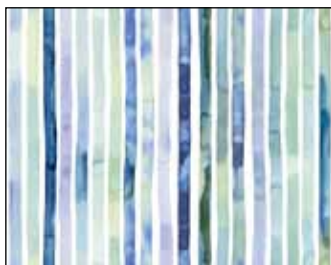

GEMS 5225 BG*

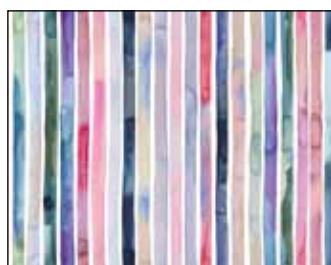

GEMS 5225 MU



CTSO 5226 DB*



CTSO 5226 LB*



CTSO 5226 LT*

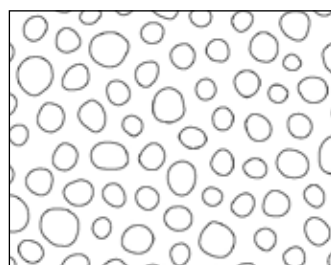

RA13 4883 W*



BOUTIQUE

P&B Textiles • pbtex.com • 800-351-9087 • 208 Clock Tower Square, Portsmouth, RI 02871

*Fabrics used in quilt.

†Backing