

michael miller FABRICS

PUMPKIN PATCH

SIZE: 54"W x 63"H • LEVEL: BEGINNER • PATTERN BY: NATALIE CRABTREE • HARVEST FARM FABRIC COLLECTION
PATTERN AVAILABLE ON: WWW.MICHAELMILLERFABRICS.COM



THIS IS A DIGITAL REPRESENTATION OF THE QUILT TOP, FABRIC MAY VARY.

PLEASE NOTE: BEFORE BEGINNING YOUR PROJECT, CHECK FOR ANY PATTERN UPDATES AT MICHAELMILLERFABRICS.COM'S FREE PROJECTS SECTION.

p.212.704.0774 | info@michaelmillerfabrics.com | www.michaelmillerfabrics.com



PUMPKIN PATCH



FABRIC A
Cotton Couture
SC_5333 Soft White
1 1/4 yards



FABRIC B
DCX10968
Harvest Orchard Cream
1 FQ



FABRIC C
DCX10969
Harvest Trucks Brown
1 FQ



FABRIC D
DCX10969
Harvest Trucks Cream
1 FQ



FABRIC E
DCX10970
Pumpkin Field Brown
1 FQ



FABRIC F
DCX10970
Pumpkin Field Cream
1 FQ



FABRIC G
DCX10970
Pumpkin Field Gold
1 FQ



FABRIC H
DCX10970
Pumpkin Field Wine
1 FQ



FABRIC I
CX10972
Apple Picking Cream
1 FQ



FABRIC J
CX10972
Apple Picking Gold
1 FQ



FABRIC K
CX10972
Apple Picking Green
1 FQ



FABRIC L
CX10973
Golden Sunflowers Gold
1 FQ



FABRIC M
CX10974
Autumn Foliage Brown
1 FQ



FABRIC N
CX10974
Autumn Foliage Wine
1 FQ



FABRIC O
CX10975
Autumn Plaids Green
1 FQ

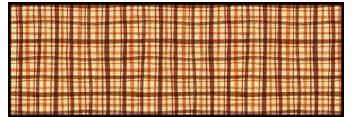

FABRIC P
CX10975
Autumn Plaids Rust
1 FQ



FABRIC Q
CX10976
Basket Texture Brown
1 FQ

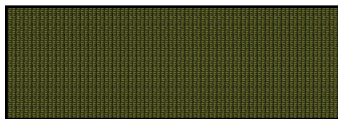

FABRIC R
CX10976
Basket Texture Green
3/8 yard or 2 FQ



FABRIC S
DCX10060
Fresco Butterscotch
3/4 yard (includes binding)



FABRIC T
DCX10060
Fresco Carrot
3/8 yard



FABRIC U
DCX10060
Fresco Lime
1/8 yard

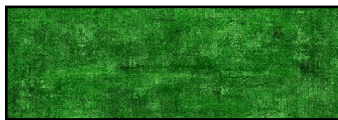

FABRIC V
DCX10060
Fresco Emerald
1/8 yard



FABRIC W
DCX10060
Fresco Caramel
1/8 yard

BACKING
3 1/2 yards

BATTING
62" x 71"



PUMPKIN PATCH

KEY	CUTTING INTRUCTIONS
A	<ul style="list-style-type: none"> • Cut (2) 10" x WOF strips. Subcut (8) 10" squares; cut each square once diagonally to make (16) HST (<i>Please note: (1) HST will be unused.</i>). Set aside for HST Blocks. • Cut (6) 1" x WOF strips. Subcut the following for Pumpkin Blocks: <ul style="list-style-type: none"> ○ (14) 1" x 9 ½" rectangles. ○ (14) 1" x 6 ½" rectangles. • Cut (2) 2 ¾" x WOF strips. Subcut the following for Pumpkin Blocks: <ul style="list-style-type: none"> ○ (7) 2 ¾" x 4 ½" rectangles. ○ (7) 2 ¾" squares. • Cut (2) 2" x WOF strips. Subcut (28) 2" squares for Pumpkin Blocks. • Cut (1) 1 ¾" x WOF strip. Subcut the following for Pumpkin Blocks: <ul style="list-style-type: none"> ○ (7) 1 ¾" squares. ○ (14) 1 ¼" squares. • Cut (1) ¾" x WOF strip. Subcut (7) ¾" x 2 ½" rectangles for Pumpkin Blocks.
**	<p>**From Fabrics B, C, D, E, F, G, H, I, J, K, L, M, N, O, P and Q:</p> <ul style="list-style-type: none"> • From each of the (16) print FQ, cut (2) 10" squares (<i>totaling (32) squares</i>). Cut each square once diagonally to make (4) HST from each print (<i>totaling (64) HST</i>) for HST Blocks. (<i>Please note that some HST will be unused.</i>)
R	<ul style="list-style-type: none"> • From either 3/8 yard or (2) FQ, cut (3) 10" squares; cut each square once diagonally to make (6) HST for HST Blocks. (<i>Please note: (1) HST will be unused.</i>)
S	<ul style="list-style-type: none"> • Cut (7) 2 ¼" x WOF strips for binding. • Cut (1) 6 ½" x WOF strip. Subcut (3) 6 ½" x 8 ¾" rectangles for Pumpkin Blocks.
T	<ul style="list-style-type: none"> • Cut (1) 6 ½" x WOF strip. Subcut (4) 6 ½" x 8 ¾" rectangles for Pumpkin Blocks.
U	<ul style="list-style-type: none"> • From yardage, cut (3) 2 ½" squares for Pumpkin Blocks.
V	<ul style="list-style-type: none"> • From yardage, cut (4) 2 ½" squares for Pumpkin Blocks.
W	<ul style="list-style-type: none"> • Cut (1) 1 ¼" x WOF strip. Subcut (7) 1 ¼" x 2 ¾" rectangles for Pumpkin Blocks.

PUMPKIN PATCH

HST Block Assembly:

1. To begin, pair together (1) 10" Fabric A HST and (1) 10" Fabric H HST, RST and edges aligned.

2. Sew along the longest edge using a 1/4" seam.

3. Triangles have been slightly oversized to allow for trimming. Trim the HST Block to measure 9 1/2" x 9 1/2" unfinished. Press toward the dark fabric.

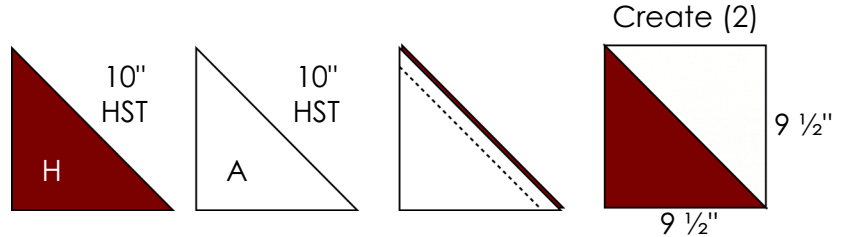

4. Repeat to make (2) A/H HST Blocks.

5. Repeat HST Block assembly described in Steps 1-3 to make (28) additional HST Block colorways. **It is strongly recommended to label each completed HST Block with the fabrics used for quick and easy reference during Quilt Assembly.** Each HST Block lists the quantity to create. There should be (35) total HST Blocks.

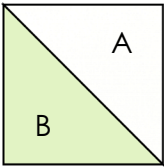
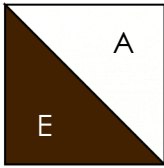
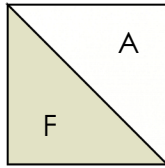
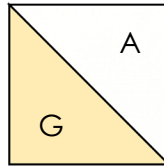
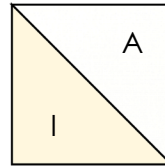
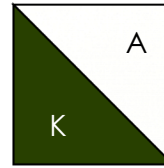
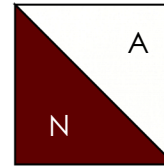
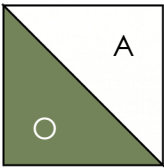
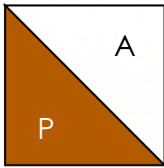
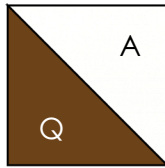
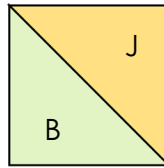
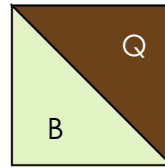
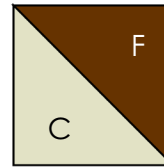
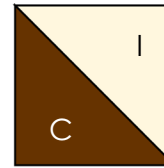
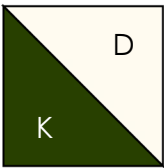
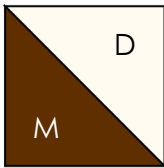
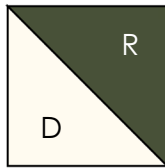
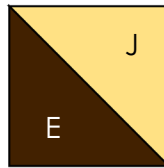
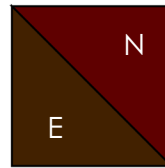
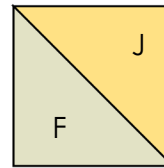
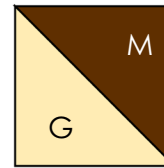
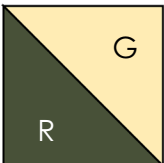
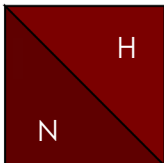
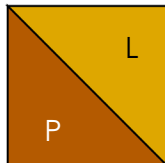
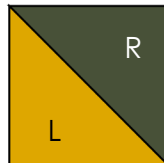
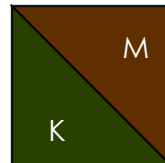
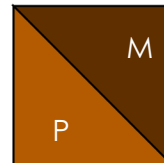
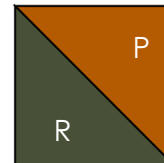
Create (1) 	Create (1) 	Create (1) 	Create (1) 	Create (1) 	Create (1) 	Create (1) 
Create (3) 	Create (1) 	Create (2) 	Create (1) 	Create (1) 	Create (1) 	Create (2) 
Create (1) 	Create (1) 	Create (1) 	Create (1) 	Create (1) 	Create (1) 	Create (1) 
Create (1) 	Create (1) 	Create (1) 	Create (2) 	Create (1) 	Create (1) 	Create (1) 

PUMPKIN PATCH

Pumpkin Block Assembly:

6. Draw a diagonal line on the wrong side of (12) 2" Fabric A squares.
7. Place (1) 2" Fabric A square onto each corner of (3) 8 3/4" x 6 1/2" Fabric S rectangles, RST and edges aligned. Note the orientation of the drawn diagonal lines in the diagram.
8. Sew along the drawn diagonal lines. Then, trim excess corner fabric to a 1/4". Press toward the corners to complete SNF techniques. Pumpkin SNF units should measure 8 3/4" x 6 1/2" unfinished.

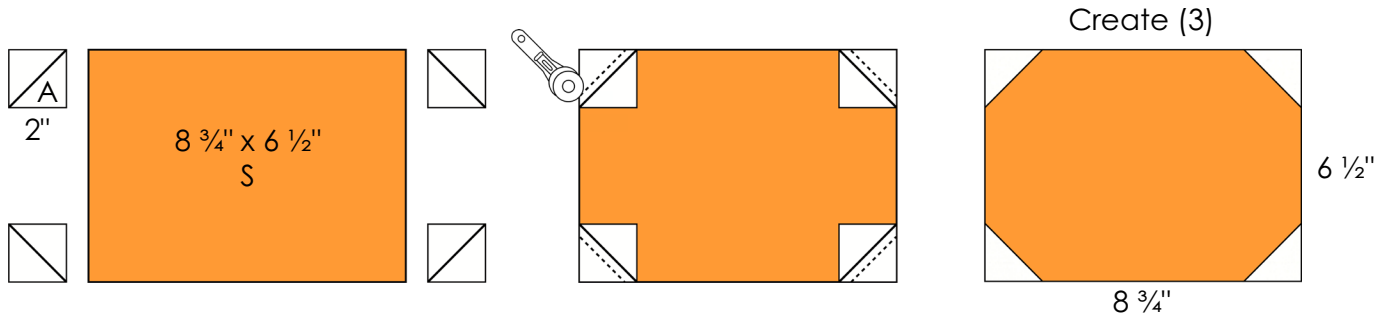

9. Draw a diagonal line on the wrong side of (3) 1 3/4" Fabric A squares and (3) 1 1/4" Fabric A squares.

10. Repeat SNF techniques to attach (1) 1 3/4" Fabric A square to the top right corner of (3) 2 1/2" Fabric U squares. Then, attach (1) 1 1/4" Fabric A square to the bottom left corner of the same Fabric U squares. Leaf SNF units should measure 2 1/2" x 2 1/2" unfinished.

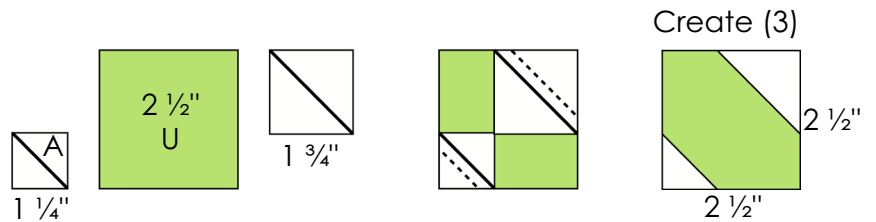

11. Draw a diagonal line on the wrong side of (7) 1 1/4" Fabric A squares.

12. Repeat SNF techniques to attach (1) 1 1/4" Fabric A square to the top left corner of (7) 1 1/4" x 2 3/4" Fabric W rectangles. Stem SNF units should measure 1 1/4" x 2 3/4" unfinished.

13. Set aside (4) Stem SNF units for Step 20.

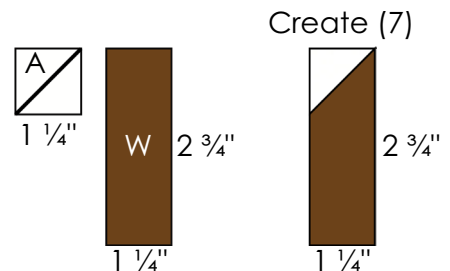

14. Sew (1) 1" x 6 1/2" Fabric A rectangle to both sides of each Pumpkin SNF unit. Press toward Fabric A.

15. Fabric A rectangles are slightly oversized (*width*). Trim the partial Pumpkin Blocks to measure 9 1/2" x 6 1/2" unfinished. Trim evenly from both sides.

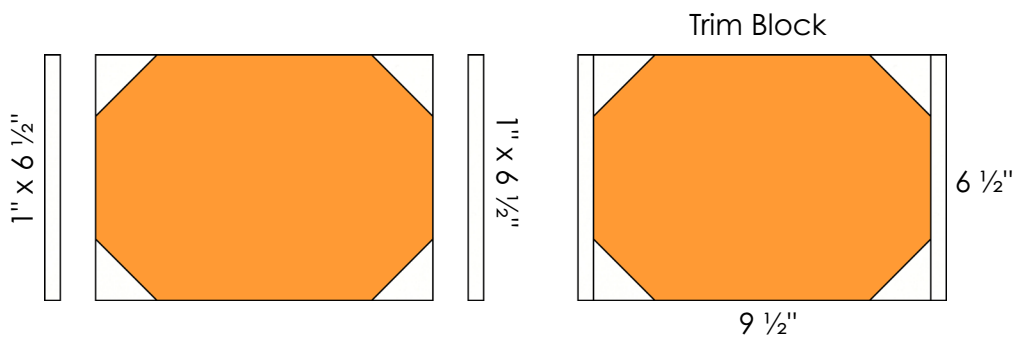

PUMPKIN PATCH

16. Arrange the trimmed partial Pumpkin Blocks with the Leaf SNF units, Stem SNF units and assorted Fabric A squares/rectangles. Reference the diagram for the size and location of each Fabric A piece.
17. Sew together as shown. Press toward Fabric A. The partial Pumpkin Block should measure $9\frac{1}{2}'' \times 8\frac{3}{4}''$ unfinished at this step.

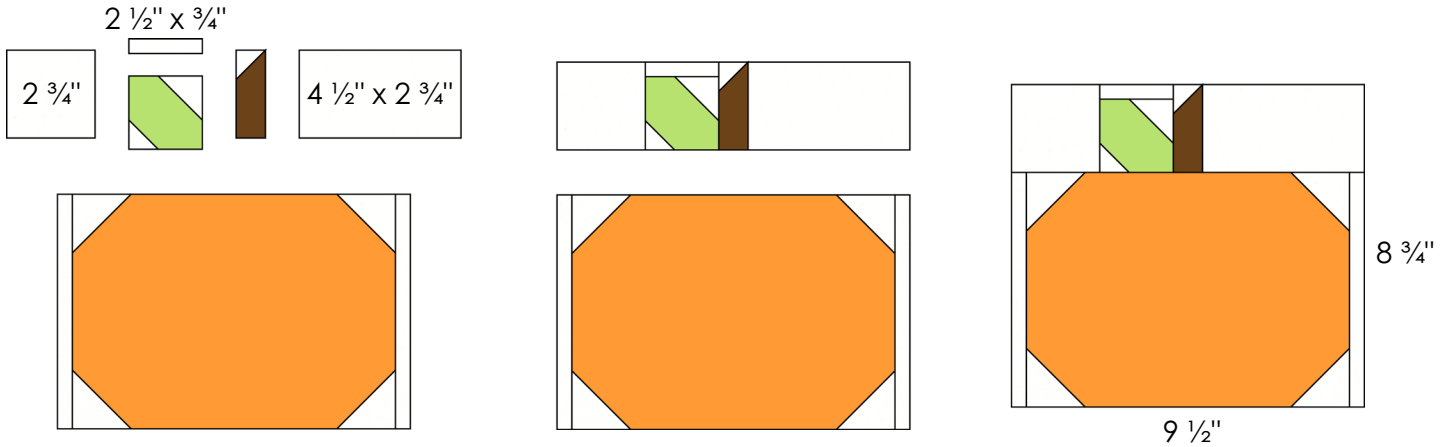

18. Sew (1) $1'' \times 9\frac{1}{2}''$ Fabric A rectangle to the top and bottom of the partial Pumpkin Block. Press toward Fabric A.
19. Fabric A rectangles are slightly oversized (*width*). Trim the Pumpkin Block to measure $9\frac{1}{2}'' \times 9\frac{1}{2}''$ unfinished. Trim evenly from the top and bottom to complete assembly. There should be (3) Pumpkin Blocks using Fabrics A, S and U.

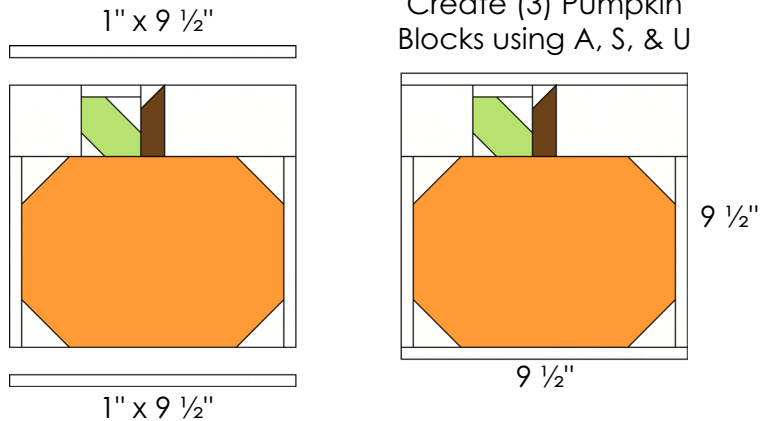

Create (3) Pumpkin Blocks using A, S, & U

20. Repeat Steps 6-19 to make (4) Pumpkin Blocks using Fabrics A, T and V. Reference the diagram for fabric placement. Be sure to trim appropriately as described in Steps 15 and 19.

Create (4) Pumpkin Blocks using A, T, & V

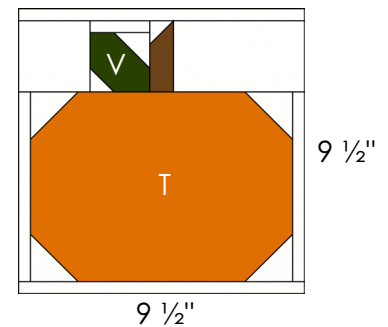

PUMPKIN PATCH

Quilt Assembly:

21. Arrange HST Blocks and Pumpkin Blocks in a 6 x 7 grid as shown in the quilt diagram below. Reference the opaque diagram to the right labeled with fabric placement for each HST Block. It is recommended to use the suggested fabric placement for even color and print distribution.
22. Sew blocks into horizontal block rows, alternating the direction in which you press the seams in each row.
23. Sew horizontal block rows together, using pins to align and nestle seams. Press horizontal seams downward. Once complete, the quilt top should measure 54 1/2" x 63 1/2" unfinished.

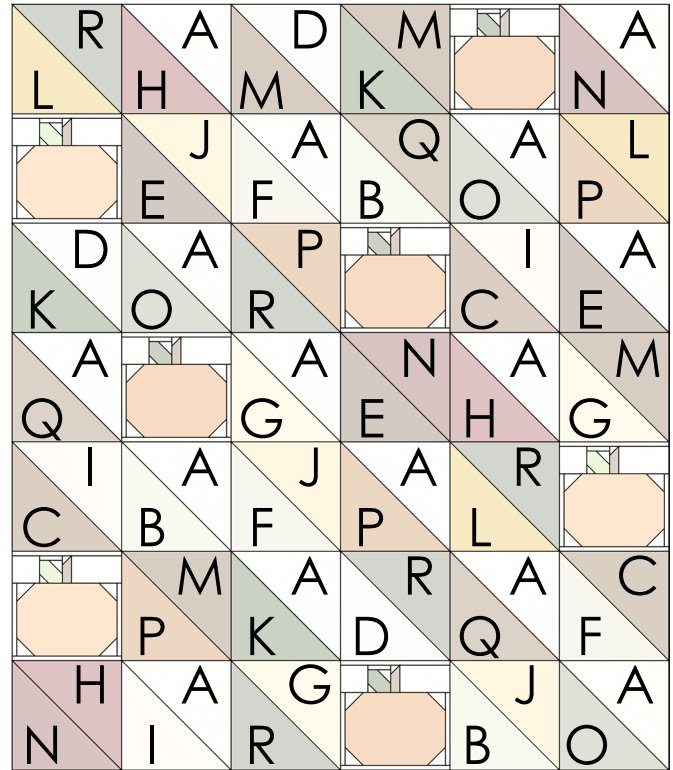

Finishing the Quilt:

24. Sandwich the quilt top with batting and backing. Baste quilt layers together using your preferred method.
25. Quilt as desired.
26. Bind quilt using (7) 2 1/4" x WOF Fabric S strips.

