

Into the Wild

Designed by Robert Kaufman Fabrics

Featuring
NORTH AMERICAN WILDLIFE





Finished quilt measures: 86" x 104"

Pattern Level: Confident Beginner

*"I have basic block construction down
and would like to learn a new trick!"*

ROBERT KAUFMAN
F A B R I C S

Fabric and Supplies Needed

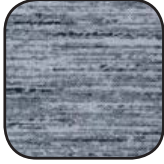
Color	Fabric	Name/SKU	Yardage	Color	Fabric	Name/SKU	Yardage
	A	K001-1470 Kona Pewter	1-1/3 yards		C	AJSP-14250-169 Earth	1-2/3 yard
	B	AJSP-14252-304 SHADOW	4-1/2 yards		D	AJSP-14252-90 Pearl	2-1/2 yards

You will also need:
5/8 yard Binding
7-3/8 yards Backing Fabric and Batting

Notes Before You Begin

- Please read through all of the instructions before beginning.
- All of the seam allowances are 1/4" unless otherwise noted.
- Width of fabric (WOF) is equal to at least 42" wide.
- Press all seam allowances open after each seam is sewn, unless otherwise noted.
- Remember to measure twice and cut once!

Printing the Diamond Templates

- Print forty-nine copies of the Diamond Block template on page 5. Do not trim the excess paper from the template.

Cutting Instructions

Fabric A

- Fussy-cut twenty squares 10-1/2" x 10-1/2".

Fabric B

- Cut eight strips 8-1/2" x WOF, then subcut into thirty squares 8-1/2" x 8-1/2".
- Cut fourteen strips 6-1/2" x WOF, then subcut into ninety-eight rectangles 5-1/2" x 6-1/2".
 - Cut each rectangle diagonally from corner to corner.



Fabric C

- Cut seven strips 8-1/2" x WOF, then subcut into twenty-five rectangles 8-1/2" x 10-1/2".

Fabric D

- Cut six strips 8-1/2" x WOF, then subcut into twenty-four rectangles 8-1/2" x 10-1/2".
- Cut ten strips 3-1/2" x WOF, then subcut two strips in half to yield four strips 3-1/2" x 21".

Step One: Paper-piece the Diamond Blocks

Shorten your machine's stitch length to about a 1.5 to paper-piece the Diamond Blocks.

- Place a Fabric C rectangle right side up on the unprinted side of the Diamond Block Template. Pin, or use a dot of glue stick to affix the fabric to the paper. (fig. 1)
- Lay a Fabric B triangle right side down so that the long edge is 1/4" over the Section 1 line. Sew along the printed line. Trim the excess fabric, leaving a 1/4" seam allowance (do NOT trim the paper.) (fig. 1).
- Flip triangle and press flat (fig. 2).
- Repeat to sew the other three triangles to the Fabric C rectangle. Trim edge of block (trim paper too), leaving a 1/4" seam allowance. Gently remove the papers. Block will measure 8-1/2" x 10-1/2" (fig. 3).
- Make a total of twenty-five blocks using Fabric C rectangles and a total of twenty-four blocks using Fabric D rectangles.

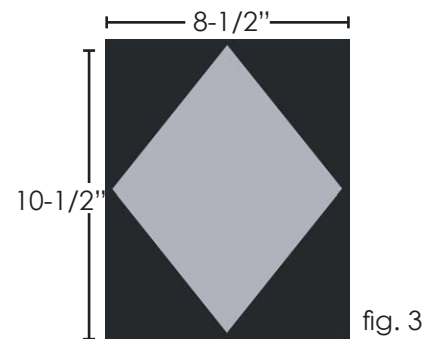
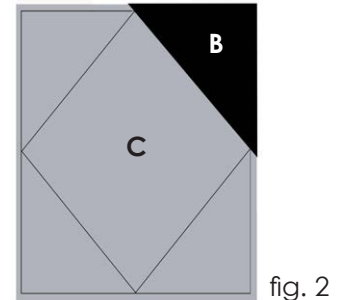
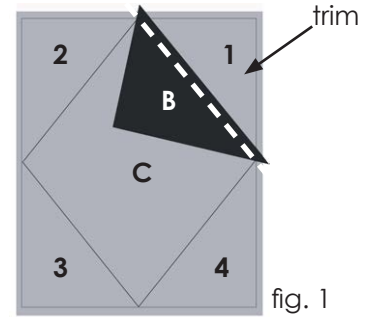

Step Two: Assemble the Rows



To make Row A: Alternate five Fabric B squares and four Fabric D diamond blocks and sew together to make a row (fig. 4). Press seam allowances toward B. Repeat to make six duplicate rows.

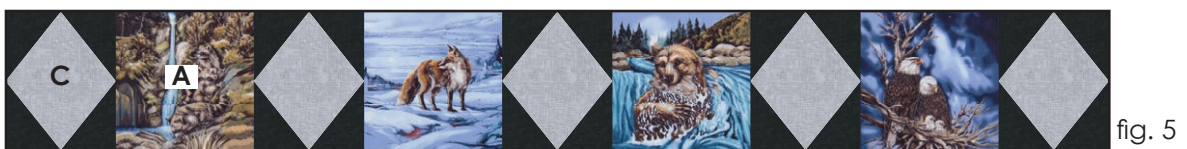

To make Row B: Alternate five Fabric C diamond blocks and four Fabric A squares and sew together to make a row (fig. 5). Press seam allowances toward A. Repeat to make five duplicate rows.

Step Three: Assemble the Quilt

- Sew the rows together, alternating Row A and Row B, to assemble the quilt top (fig. 6).

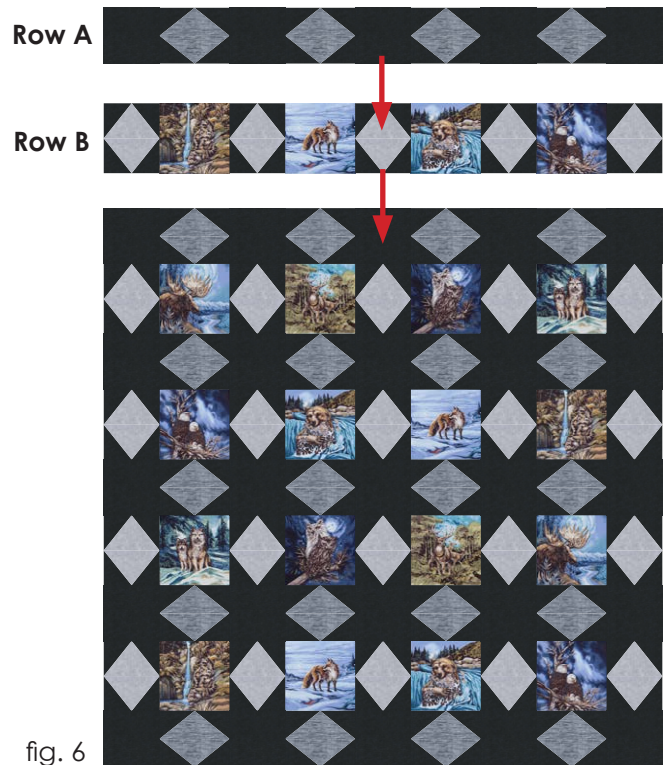

Step Four: Attach the Borders

- Sew two Fabric D 3-1/2" x WOF strips and one Fabric D 3-1/2" x 21" strip, short ends together, to make one long border strip. Repeat to make a total of four border strips.
- Sew border strips to the sides of the quilt top and trim excess fabric from the ends.
- Sew border strips to the top and bottom of the quilt top and trim excess fabric from the ends.

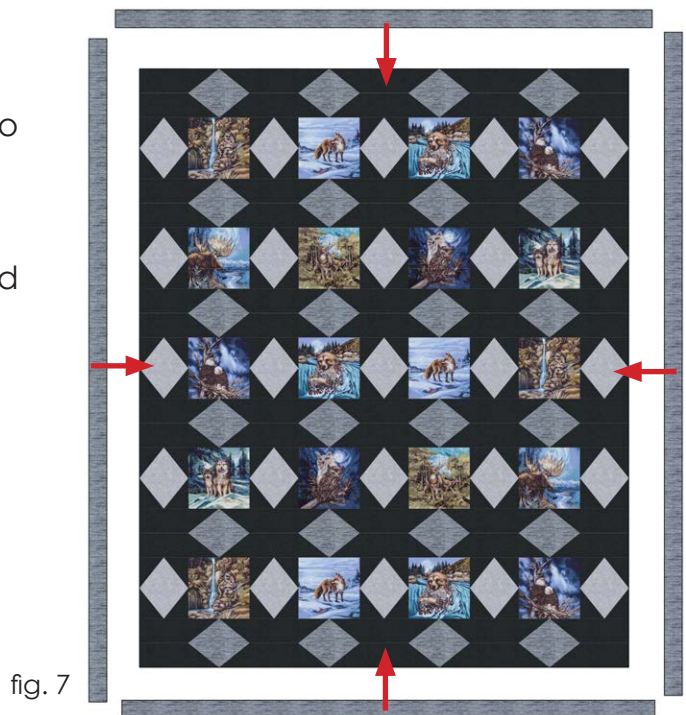

Your quilt top is complete! Baste, quilt, bind & enjoy.

2

1

Into the Wild
Diamond Block Template
print at 100%

1 inch

3

4