

Fractal Flowers

• A Free Project Sheet •
• NOT FOR RESALE •

QUILT 2

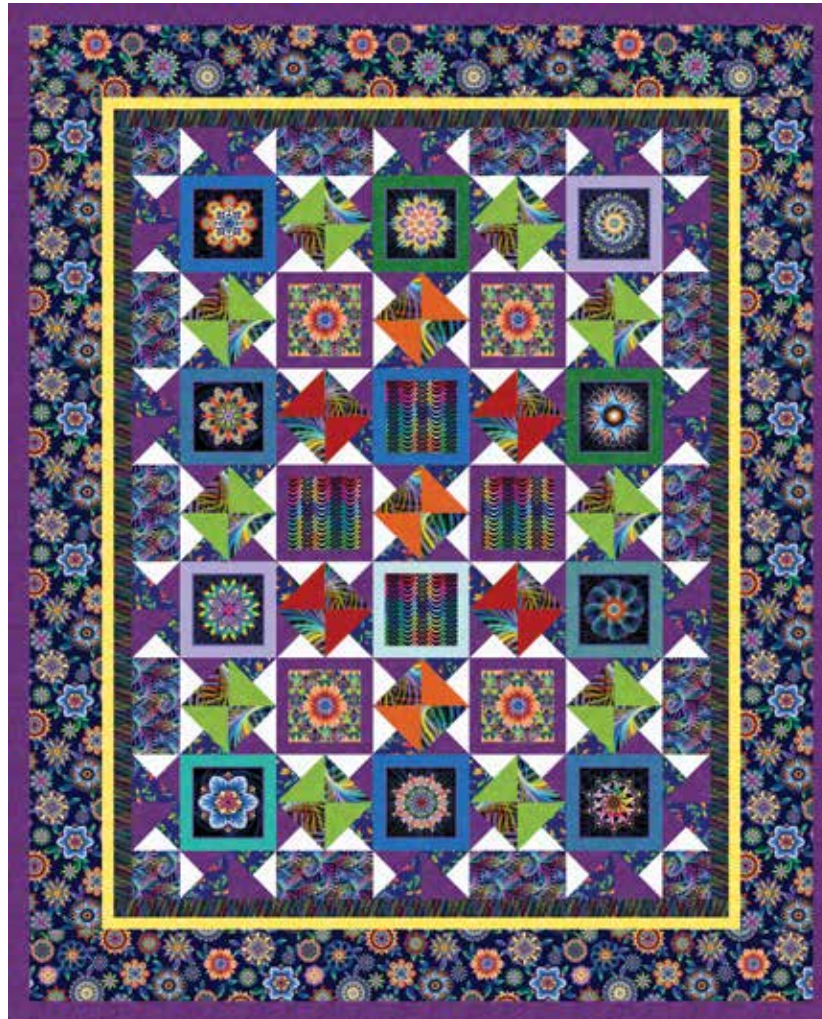

Featuring fabrics from the **Fractal Flowers** collection by **Art Loft** for **STUDIO e fabrics**

Fabric Requirements

(A) 6638-77	2/3 yard	(M) 1351-Grass** ...	3/8 yard
(B) 1351-Aegean Blue**	1/4 yard	(N) 1351-Pigment White**	1/2 yard
(C) 1351-Green**....	1/4 yard	(O) 6631-77	1/2 yard
(D) 1351-Orchid	1/4 yard	(P) 1351-Orange**	1/4 yard
(E) 1351-Denim	1/4 yard	(Q) 1351- Burgundy**	1/4 yard
(F) 1351-Aqua	1/8 yard	(R) 6635-77	5/8 yard
(G) 1351-Teal	1/8 yard	(S) 6632-77	1/2 yard
(H) 6633-77	1/3 yard	(T) 1351-Sunshine**	3/8 yard
(I) 1351-Grape**.....	1 3/4 yards*	(U) 6630-77	1 5/8 yards
(J) 6637-77	1/4 yard	(Backing)	
(K) 1351-Sea Glass**	1/8 yard	6630-11	5 1/4 yards
(L) 6636-77	1/2 yard		

Additional Supplies Needed

Batting 76" x 92" (Recommended:
Air Lite® Colour Me 100% Cotton)
Piecing and sewing thread
Quilting and sewing supplies

Quilt designed by Heidi Pridemore
Finished Quilt Size 68" x 84"
Skill Level: Intermediate

* Includes Binding
** Just Color! Collection

Please check our website for pattern updates before starting this project.

Fabrics in the Collection



Flower Allover
White - 6630-11



Flower Allover
Indigo - 6630-77

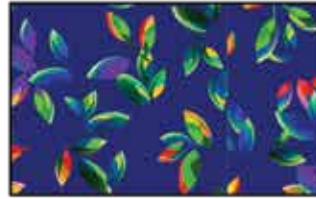

Tossed Leaves
Indigo - 6631-77



Dotty Diagonal
White - 6632-11



Dotty Diagonal
Indigo - 6632-77



Kaleidoscope Floral
Indigo - 6633-77

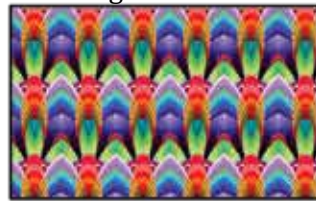

Nouveau Geo
Indigo Multi - 6634-77



Spirals
Indigo Multi - 6635-77



Whirling Striations
Indigo Multi - 6636-77



Fractal Flower Blocks
Indigo Multi - 6638-77



Wave Geo
Indigo Multi - 6637-77



Fractal Vase Panel - 24 x 44
Indigo Multi - 6639P-77

Select Fabrics from Just Color!



Aegean Blue
1351-Aegean Blue



Aqua
1351-Aqua



Burgundy
1351-Burgundy



Denim
1351-Denim



Grape
1351-Grape



Grass
1351-Grape



Green
1351-Green



Orange
1351-Orange

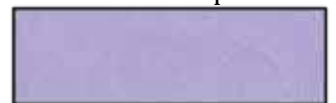

Orchid
1351-Orchid



Pigment White
1351-Pigment White

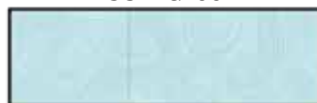

Sea Glass
1351-Sea Glass



Sunshine
1351-Sunshine



Teal
1351-Teal

Cutting

Cutting Instructions

Please note: All strips are cut across the width of fabric (WOF) from selvage to selvage edge unless otherwise noted.

WOF= Width of Fabric • LOF = Length of Fabric

Fabric A (6638-77 Fractal Flower Blocks – Indigo Multi):

- Fussy cut (10) 6 ½" squares, each centered on a block.

Fabric B (1351-Aegean Blue Just Color! – Aegean Blue), cut:

- (1) 2" x WOF strip, sub-cut (4) 2" x 6 ½" strips.
- (1) 2" x WOF strip, sub-cut (4) 2" x 9 ½" strips.
- (1) 1 ½" x WOF strip, sub-cut (2) 1 ½" x 8 ½" strips and (2) 1 ½" x 6 ½" strips.

Fabric C (1351-Green Just Color! – Green), cut:

- (1) 2" x WOF strip, sub-cut (4) 2" x 6 ½" strips.
- (1) 2" x WOF strip, sub-cut (4) 2" x 9 ½" strips.

Fabric D (1351-Orchid Just Color! – Orchid), cut:

- (1) 2" x WOF strip, sub-cut (4) 2" x 6 ½" strips.
- (1) 2" x WOF strip, sub-cut (4) 2" x 9 ½" strips.

Fabric E (1351-Denim Just Color! – Denim), cut:

- (1) 2" x WOF strip, sub-cut (4) 2" x 6 ½" strips.
- (1) 2" x WOF strip, sub-cut (4) 2" x 9 ½" strips.

Fabric F (1351-Aqua Just Color! – Aqua), cut:

- (1) 2" x WOF strip, sub-cut (2) 2" x 9 ½" strips and (2) 2" x 6 ½" strips.

Fabric G (1351-Teal Just Color! – Teal), cut:

- (1) 1 ½" x WOF strip, sub-cut (2) 1 ½" x 8 ½" strips and (2) 1 ½" x 6 ½" strips.

Fabric H (6633-77 Kaleidoscope Floral – Indigo):

- Fussy cut (4) 6 ½" squares, each centered on a large flower.

Fabric I (1351-Grape Just Color! – Grape), cut:

- (2) 5 ¼" x WOF strips, sub-cut (12) 5 ¼" squares. Cut the squares across both diagonals to make (48) 5 ¼" triangles.
- (1) 4 ⅞" x WOF strip, sub-cut (7) 4 ⅞" squares. Cut the squares across (1) diagonal to make (14) 4 ⅞" triangles.
- (4) 2" x WOF strips. Sew the strips together end to end with diagonal seams and cut (2) 2" x 81 ½" strips.
- (4) 2" x WOF strips. Sew the strips together end to end with diagonal seams and cut (2) 2" x 68 ½" strips.
- (2) 1 ½" x WOF strips, sub-cut (12) 1 ½" x 6 ½" strips.
- (3) 1 ½" x WOF strips, sub-cut (12) 1 ½" x 8 ½" strips.
- (8) 2 ½" x WOF strips for the binding.

Fabric J (6637-77 Wave Geo – Indigo Multi), cut:

- (1) 6 ½" x WOF strip, sub-cut (4) 6 ½" squares.

Fabric K (1351-Sea Glass Just Color – Sea Glass), cut:

- (1) 1 ½" x WOF strip, sub-cut (2) 1 ½" x 8 ½" strips and (2) 1 ½" x 6 ½" strips.

Fabric L (6636-77 Whirling Striations – Indigo Multi), cut:

- (3) 4 ⅞" x WOF strips, sub-cut (17) 4 ⅞" squares. Cut the squares across (1) diagonal to make (34) 4 ⅞" triangles.

Cutting - Continued

Fabric M (1351-Grass Just Color! – Grass), cut:

- (2) 4 7/8" x WOF strips, sub-cut (10) 4 7/8" squares. Cut the squares across (1) diagonal to make (20) 4 7/8" triangles.

Fabric N (1351-Pigment White Just Color! – Pigment White), cut:

- (3) 5 1/4" x WOF strips, sub-cut (24) 5 1/4" squares. Cut the squares across both diagonals to make (96) 5 1/4" triangles.

Fabric O (6631-77 Tossed Leaves – Indigo), cut:

- (2) 5 1/4" x WOF strips, sub-cut (12) 5 1/4" squares. Cut the squares across both diagonals to make (48) 5 1/4" triangles.
- (1) 4 7/8" x WOF strip, sub-cut (7) 4 7/8" squares. Cut the squares across (1) diagonal to make (14) 4 7/8" triangles.

Fabric P (1351-Orange Just Color! – Orange), cut:

- (1) 4 7/8" x WOF strip, sub-cut (3) 4 7/8" squares. Cut the squares across (1) diagonal to make (6) 4 7/8" triangles.

Fabric Q (1351-Burgundy Just Color! – Burgundy), cut:

- (1) 4 7/8" x WOF strip, sub-cut (4) 4 7/8" squares. Cut the squares across (1) diagonal to make (8) 4 7/8" triangles.

Fabric R (6635-77 Spirals – Indigo Multi), cut:

- (1) 4 1/2" x WOF strip, sub-cut (4) 4 1/2" squares.
- (3) 4 1/2" x WOF strips, sub-cut (10) 4 1/2" x 8 1/2" strips.

Fabric S (6632-77 Dotty Diagonal – Indigo), cut:

- (4) 2" x WOF strips. Sew the strips together end to end with diagonal seams and cut (2) 2" x 64 1/2" strips.
- (3) 2" x WOF strips. Sew the strips together end to end with diagonal seams and cut (2) 2" x 51 1/2" strips.

Fabric T (1351-Sunshine Just Color! – Sunshine), cut:

- (4) 1 1/2" x WOF strips. Sew the strips together end to end with diagonal seams and cut (2) 1 1/2" x 67 1/2" strips.
- (3) 1 1/2" x WOF strips. Sew the strips together end to end with diagonal seams and cut (2) 1 1/2" x 53 1/2" strips.

Fabric U (6630-77 Flower Allover – Indigo), cut:

- (4) 6 1/2" x WOF strips. Sew the strips together end to end with diagonal seams and cut (2) 6 1/2" x 69 1/2" strips.
- (4) 6 1/2" x WOF strips. Sew the strips together end to end with diagonal seams and cut (2) 6 1/2" x 65 1/2" strips.

Backing (6630-11 Flower Allover – White), cut:

- (2) 92" x WOF strips for the backing. Sew the strips together and trim to make the 76" x 92" back.

Sewing

Sew using a $\frac{1}{4}$ " seam allowance with right sides together (RST) unless otherwise indicated. Always press towards the darker fabric while assembling, unless otherwise noted by the arrows.

Block Assembly

Note: The arrows in figures represent the fabric print direction. Pay attention to the fabric and unit orientations when assembling the various components.

1. Sew (1) $2'' \times 6\frac{1}{2}''$ Fabric B strip to each side of (1) $6\frac{1}{2}''$ Fabric A square. Sew (1) $2'' \times 9\frac{1}{2}''$ Fabric B strip to the top and to the bottom of the Fabric A square to make (1) Block One square (Fig. 1). **Trim the block to measure $8\frac{1}{2}'' \times 8\frac{1}{2}''$.** Repeat to make a second Block One square.

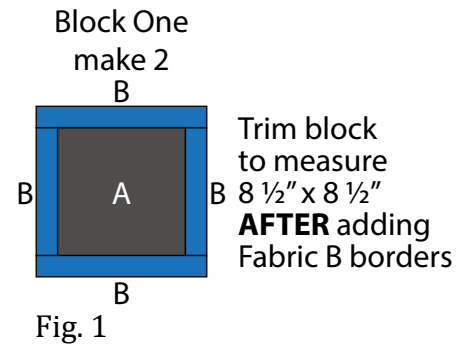

2. Repeat Step 1 and refer to Figures 2-3 for fabric identification, placement and orientation to make (2) Block Two squares and (2) Block Three squares.

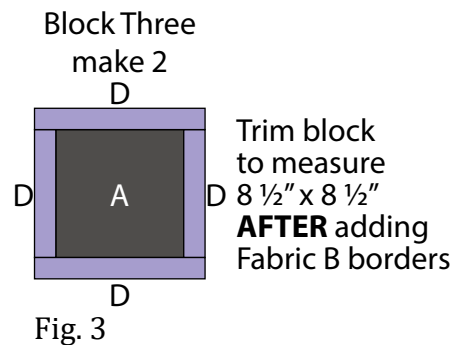
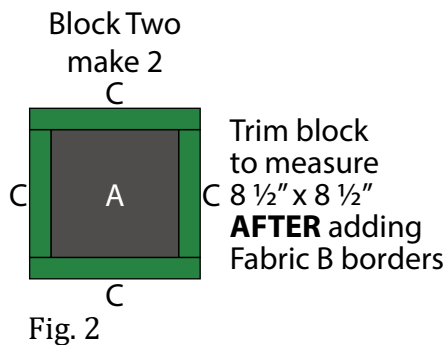

3. Sew (1) $1\frac{1}{2}'' \times 6\frac{1}{2}''$ Fabric I strip to each side of (1) $6\frac{1}{2}''$ Fabric H square. Sew (1) $1\frac{1}{2}'' \times 8\frac{1}{2}''$ Fabric I strip to the top and to the bottom of the Fabric H square to make (1) Block Four square (Fig. 4). Repeat to make (4) Block Four squares total.

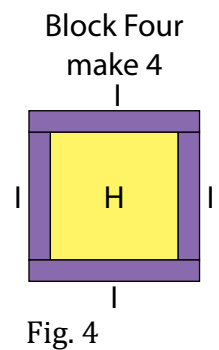

4. Repeat Step 1 and refer to Figure 5 for fabric identification, placement and orientation to make (2) Block Five squares.

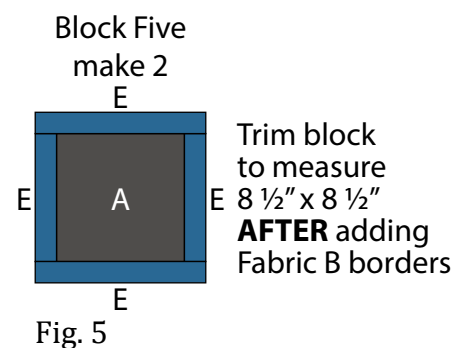

5. Repeat Step 3 and refer to Figures 6-8 for fabric identification, placement and orientation to make (1) Block Six square, (2) Block Seven squares and (1) Block Eight square.

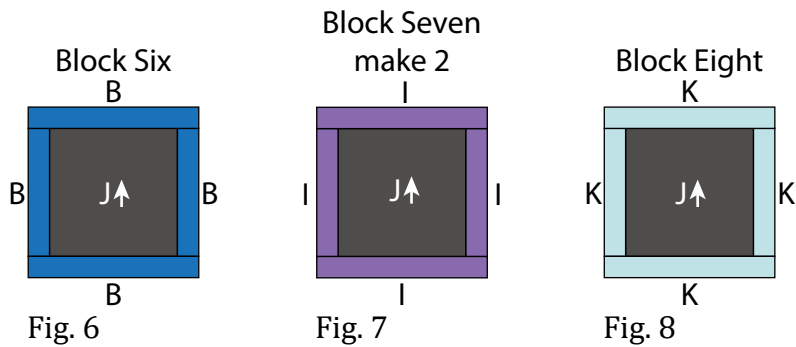

6. Repeat Step 1 and refer to Figures 9-10 for fabric identification, placement and orientation to make (1) Block Nine square and (1) Block Ten square.

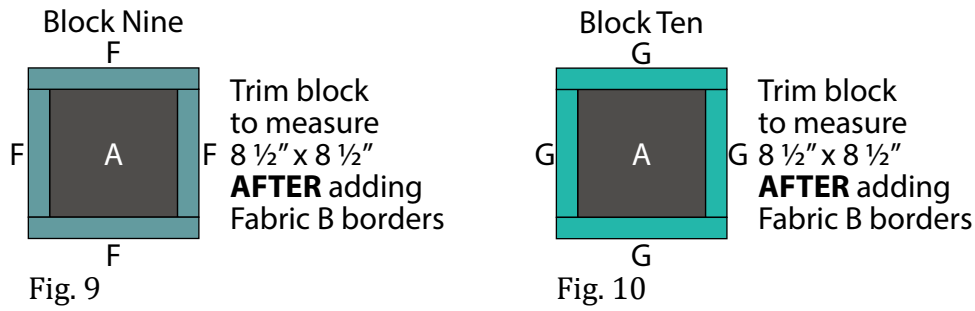

7. Sew together (1) 5 1/4" x Fabric N triangle and (1) 5 1/4" Fabric O triangle along short sides. Sew (1) 4 7/8" Fabric I triangle to the long side of the newly sewn triangle to make (1) 4 1/2" Unit 1 square (Fig. 11). Repeat to make (14) Unit 1 squares total.



8. Repeat Step 7 and refer to Figures 12-16 for fabric identification, placement and orientation to make (14) Unit 2 squares, (20) Unit 3 squares, (34) Unit 4 squares, (6) Unit 5 squares and (8) Unit 6 squares.

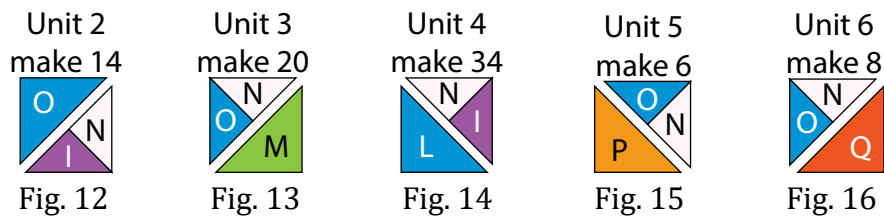

9. Sew (1) Unit 1 square to the left side of (1) Unit 2 square to make (1) Block Eleven rectangle (Fig. 17). Repeat to make (14) 4 1/2" x 8 1/2" Block Eleven rectangles total.

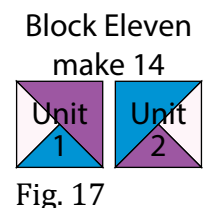

10. Sew (1) Unit 3 square to the left side of (1) Unit 4. Repeat to make a second strip. Paying attention to the orientation of the strips, sew together the (2) strips lengthwise to make (1) 8 1/2" Block Twelve square (Fig. 18). Repeat to make (10) Block Twelve squares total.

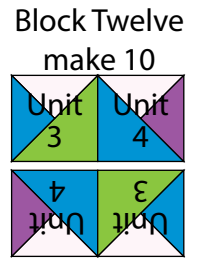

Fig. 18

11. Repeat Step 10 and refer to Figures 19-20 for component identification, placement and orientation to make (3) Block Thirteen squares and (4) Block Fourteen squares.

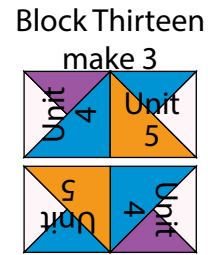

Fig. 19

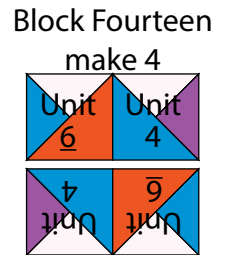

Fig. 20

12. Sew together (3) Unit 11 rectangles and (2) 4 1/2" x 8 1/2" Fabric R strips, end to end and alternating them from left to right. Sew (1) 4 1/2" Fabric R square to each end of the newly sewn strip to make Row One (Fig. 21). Repeat to make Row Nine.

13. Refer to Figure 21 and sew together the assorted 8 1/2" Blocks and 4 1/2" x 8 1/2" Fabric R strips to make Row Two through Row Eight.

14. Sew together the (9) Rows from Steps 12-13, lengthwise and in numerical order from top to bottom, to make the 48 1/2" x 64 1/2" Center Block (Fig. 21).

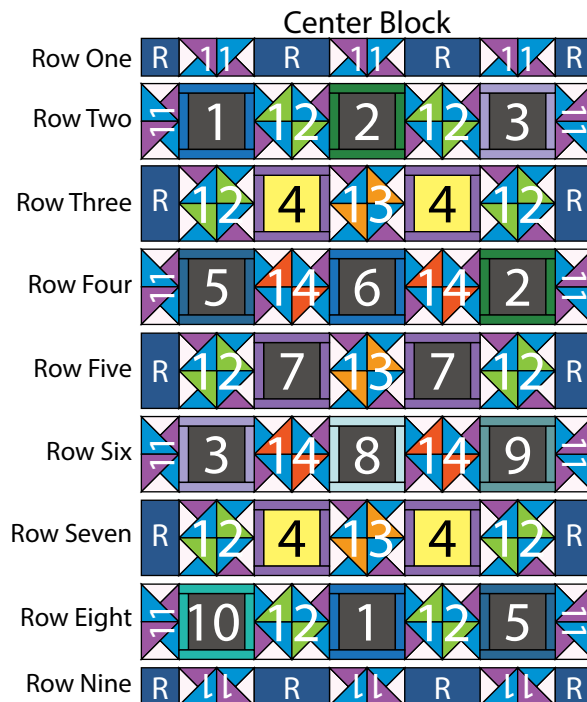

Fig. 21

Quilt Top Assembly

(Follow the Quilt Layout while assembling the quilt top.)

13. Sew (1) 2" x 64 ½" Fabric S strip to each side of the Center Block. Sew (1) 2" x 51 ½" Fabric S strip to the top and to the bottom of the Center Block.

14. Sew (1) 1 ½" x 67 ½" Fabric T strip to each side of the Center Block. Sew (1) 1 ½" x 53 ½" Fabric T strip to the top and to the bottom of the Center Block.

15. Sew (1) 6 ½" x 69 ½" Fabric U strip to each side of the Center Block. Sew (1) 6 ½" x 65 ½" Fabric U strip to the top and to the bottom of the Center Block.

16. Sew (1) 2" x 81 ½" Fabric I strip to each side of the Center Block. Sew (1) 2" x 68 ½" Fabric I strip to the top and to the bottom of the Center Block to make the quilt top.

Layering, Quilting and Finishing

17. Press the quilt top and 67" x 85" backing well. Layer backing (wrong side up), batting, pressed quilt top (right side up) and baste. Quilt as desired and trim excess batting and backing when quilting is complete.

Binding

18. Cut the ends of the (8) Fabric I binding strips at a 45-degree angle and sew end to end to make (1) continuous piece of binding. Fold in half lengthwise and press wrong sides together.

19. Sew the binding to the front of the quilt, raw edges together. Turn the folded edge to the back, and hand stitch in place.

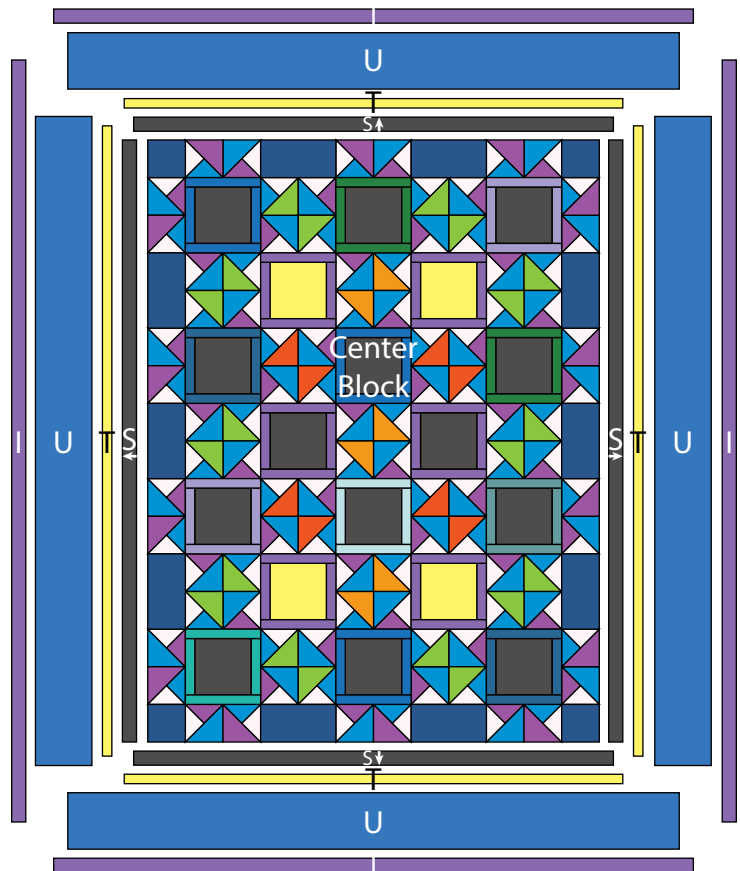

Quilt Layout

*Every effort has been made to ensure that all projects are error free. All the information is presented in good faith, however no warranty can be given nor results guaranteed as we have no control over the execution of instructions. Therefore, we assume no responsibility for the use of this information or damages that may occur as a result. When errors are brought to our attention, we make every effort to correct and post a revision as soon as possible. Please make sure to check www.studioefabrics.net for pattern updates prior to starting the project. We also recommend that you test the project prior to cutting for kits. Finally, all free projects are intended to remain free to you and are **not for resale**.*