



TOUCH OF Spring Town Quilt



Featuring the
Touch of Spring Collection
by Beth Albert
Shipping to stores January 2022

Finished Size: 73 in x 73 in (185.42 cm x 185.42 cm)

Fabric Needed

3 Wishes Fabric® Touch of Spring Collection

- 1 Panel – Town Panel (18744-PNL-CTN-D)
- 1 Panel – Dwelling Panel (18751-PNL-CTN-D)
- 1 ¼ yds – Shelves (18748-BLU-CTN-D) for Piecing and Binding
- ¾ yd – Floral (18749-MLT-CTN-D)
- ½ yd – Garden Tools (18752-GRN-CTN-D)
- ½ yd – Seed Packets (18753-BGE-CTN-D)
- ⅛ yd – Bunnies (18746-PNK-CTN-D)
- 4 ½ yds – Spring Patch (18750-WHT-CTN-D) for Backing

3 Wishes Fabric® Good Vibes Collection

- 2 ⅛ yds – Circle Dots (18660-WOW-CTN-D)

Additional Supplies Needed:

- 81 in x 81 in Cotton batting
- Piecing and sewing thread
- Quilting and sewing supplies
- Even-feed foot (optional for quilting)

Before You Begin

Read all instructions before beginning project. Do not pre-wash fabrics. Press fabrics with a dry iron on cotton setting before cutting. Use a ¼ in (6.35 mm) seam allowance and sew fabrics with right sides together (RST) unless otherwise noted. Press seams in the direction of the arrows. wof = width of fabric

Note: A printed panel may become slightly skewed during the finishing process. Check if panel is square before cutting by folding the panel so selvages meet. If all edges do not meet, pull firmly from corner to corner until the edges meet. Continue until all corners are square.

Cutting

Use a rotary cutter and ruler to cut the size and number of squares and rectangles from each fabric listed below.



Town Panel – 18744-PNL-CTN-D (36 in x wof / 91.44 cm x 106.68 cm)
Fussy Cut 1 – 24 ½ in x 24 ½ in (62.23 cm x 62.23 cm)



Dwelling Panel – 18751-PNL-CTN-D (36 in x wof / 91.44 cm x 106.68 cm)
Fussy Cut 8 – 10 ½ in x 10 ½ in (26.67 cm x 26.67 cm)

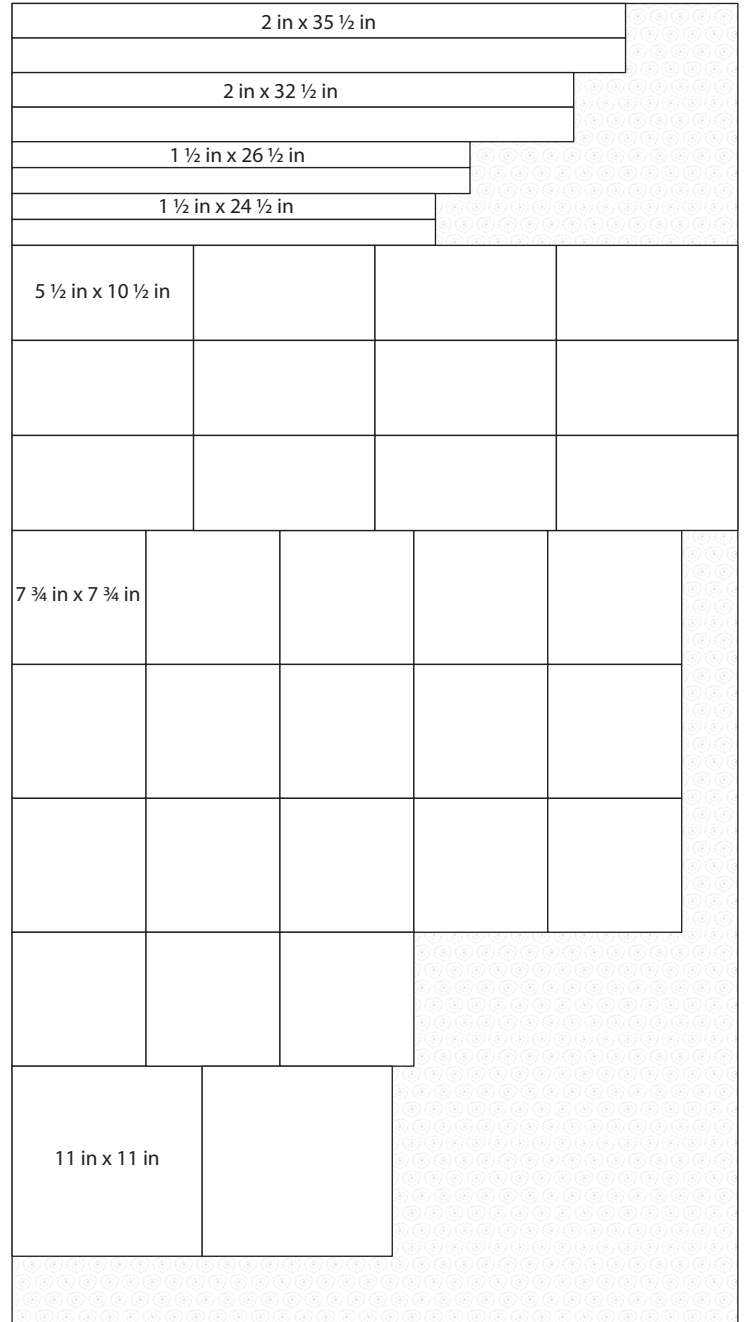

Circle Dots – 18660-WOW-CTN-D (2 ½ yds x wof / 194.31 cm x 106.68 cm)
from the 3W Good Vibes Collection

- Cut 2 – 2 in x 35 ½ in (5.08 cm x 90.17 cm)
- Cut 2 – 2 in x 32 ½ in (5.08 cm x 82.55 cm)
- Cut 2 – 1 ½ in x 26 ½ in (3.81 cm x 67.31 cm)
- Cut 2 – 1 ½ in x 24 ½ in (3.81 cm x 62.23 cm)
- Cut 12 – 5 ½ in x 10 ½ in (13.97 cm x 26.67 cm)
- Cut 18 – 7 ¾ in x 7 ¾ in (19.69 cm x 19.69 cm)
- Cut 2 – 11 in x 11 in (27.94 cm x 27.94 cm)



Shelves – 18748-BLU-CTN-D (1 1/4 yds x wof / 114.3 cm x 106.68 cm)

Cut 8 – 2 1/2 in x wof (6.35 cm x 106.68 cm) for Binding

Cut 4 – 2 in x 29 1/2 in (5.08 cm x 74.93 cm)

Cut 4 – 2 in x 28 in (5.08 cm x 71.12 cm)

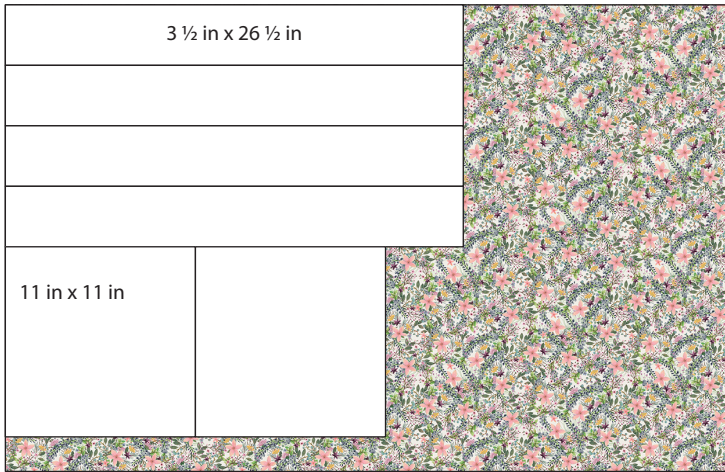

Floral – 18749-MLT-CTN-D (3/4 yd x wof / 68.58 cm x 106.68 cm)

Cut 4 – 3 1/2 in x 26 1/2 in (8.89 cm x 67.31 cm)

Cut 2 – 11 in x 11 in (27.94 cm x 27.94 cm)

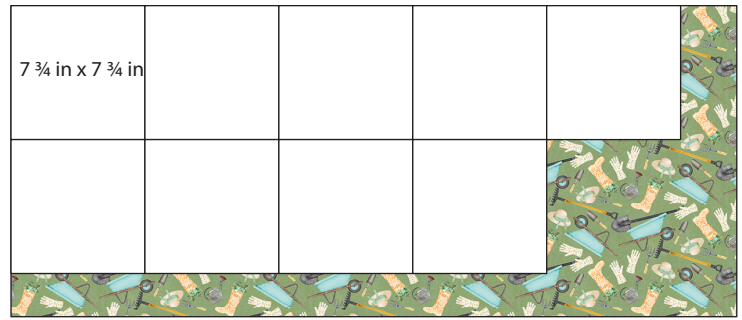

Garden Tools – 18752-GRN-CTN-D (1/2 yd x wof / 45.72 cm x 106.68 cm)

Cut 9 – 7 3/4 in x 7 3/4 in (19.69 cm x 19.69 cm)

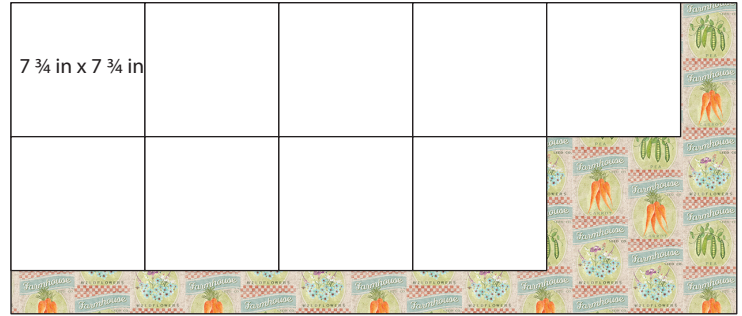

Seed Packets – 18753-BGE-CTN-D (1/2 yd x wof / 45.72 cm x 106.68 cm)

Cut 9 – 7 3/4 in x 7 3/4 in (19.69 cm x 19.69 cm)



Bunnies – 18746-PNK-CTN-D (1/8 yd x wof / 11.43 cm x 106.68 cm)

Cut 4 – 3 1/2 in x 3 1/2 in (8.89 cm x 8.89 cm)

Sewing

- Place a Bunnies square $3\frac{1}{2}$ in x $3\frac{1}{2}$ in (8.89 cm x 8.89 cm) on each side of a Floral rectangle $3\frac{1}{2}$ in x $26\frac{1}{2}$ in (8.89 cm x 67.31 cm) as shown in Diagram A. **Note:** Check orientation of design. Pin RST, sew and press to make the Floral Top Border $3\frac{1}{2}$ in x $32\frac{1}{2}$ in (8.89 cm x 82.55 cm). Repeat to make the Floral Bottom Border.

Dia. A



- Refer to Diagram B to place the Borders around the Fussy Cut Town Panel $24\frac{1}{2}$ in x $24\frac{1}{2}$ in (62.23 cm x 62.23 cm). Sew each Border RST in the order listed. Pin matching center, seams and ends. **Note:** Check orientation of design. Press seams as shown. Measure at each step to ensure the next border will fit. **Tip:** If one border is a little larger than the border it is being sewn to, pin well to ease the fullness and place the fullness on the bottom while sewing. The Quilt Center should measure $35\frac{1}{2}$ in x $35\frac{1}{2}$ in (90.17 cm x 90.17 cm).

Inner Circle Dots Border

Sides: 2 – Circle Dots strips $1\frac{1}{2}$ in x $24\frac{1}{2}$ in (3.81 cm x 62.23 cm)

Top and Bottom: 2 – Circle Dots strips $1\frac{1}{2}$ in x $26\frac{1}{2}$ in (3.81 cm x 67.31 cm)

Quilt Center – $26\frac{1}{2}$ in x $26\frac{1}{2}$ in (67.31 cm x 67.31 cm).

Floral Border

Sides: 2 – Floral rectangles $3\frac{1}{2}$ in x $26\frac{1}{2}$ in (8.89 cm x 67.31 cm)

Top and Bottom: Top and Bottom Borders $3\frac{1}{2}$ in x $32\frac{1}{2}$ in (8.89 cm x 82.55 cm); made in Step 1

Quilt Top – $32\frac{1}{2}$ in x $32\frac{1}{2}$ in (82.55 cm x 82.55 cm).

Outer Circle Dots Border

Sides: 2 – Circle Dots strips 2 in x $32\frac{1}{2}$ in (5.08 cm x 82.55 cm)

Top and Bottom: 2 – Circle Dots strips 2 in x $35\frac{1}{2}$ in (5.08 cm x 90.17 cm)

Quilt Center – $35\frac{1}{2}$ in x $35\frac{1}{2}$ in (90.17 cm x 90.17 cm).

Dia. B

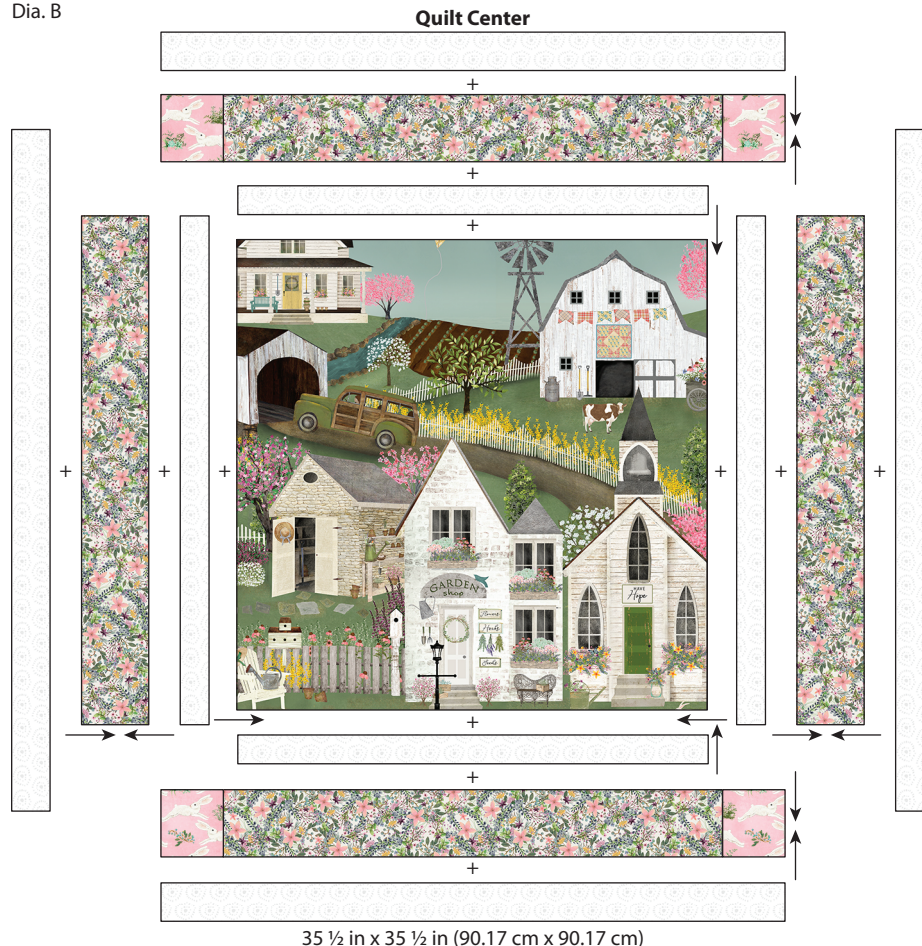

3. Draw a diagonal line on the **wrong** side of a Circle Dots square 11 in x 11 in (27.94 cm x 27.94 cm) as shown in Diagram C. Place on top of a Floral square 11 in x 11 in (27.94 cm x 27.94 cm) RST and sew $\frac{1}{4}$ in (6.35 mm) away from the line on both sides. Cut on the drawn line; press and trim if necessary. **Note:** Two squares yield two Half-Square Triangle (HST) Units. Repeat to make a total of four Half-Square Triangle Units $10\frac{1}{2}$ in x $10\frac{1}{2}$ in (26.67 cm x 26.67 cm).

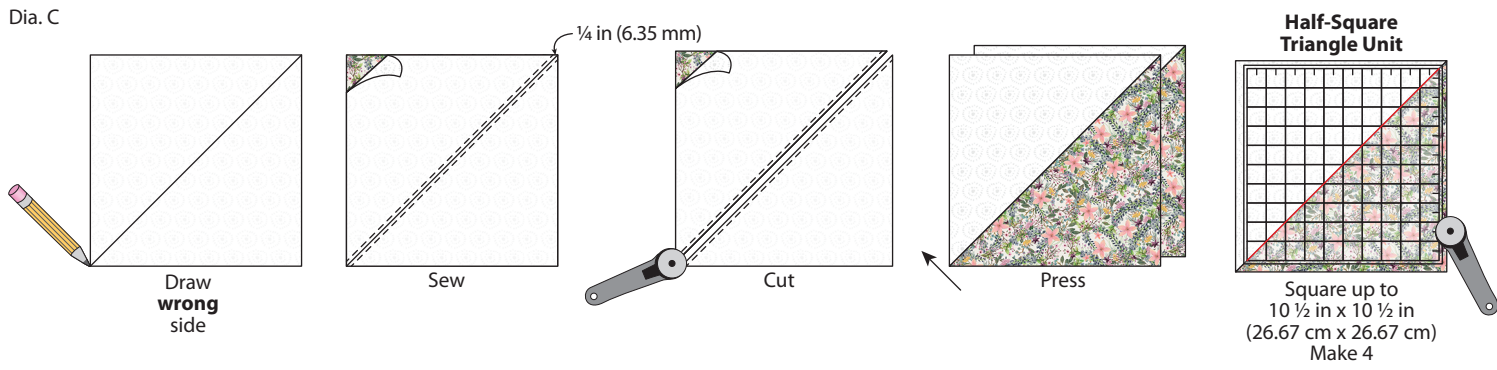

4. Place three Circle Dots rectangles $5\frac{1}{2}$ in x $10\frac{1}{2}$ in (13.97 cm x 26.67 cm) with two Fussy Cut Dwelling Panel squares $10\frac{1}{2}$ in x $10\frac{1}{2}$ in (26.67 cm x 26.67 cm) as shown in Diagram D. Pin RST, sew and press toward the Dwelling squares to make the Dwelling Left Side Border $10\frac{1}{2}$ in x $35\frac{1}{2}$ in (26.67 cm x 90.17 cm).

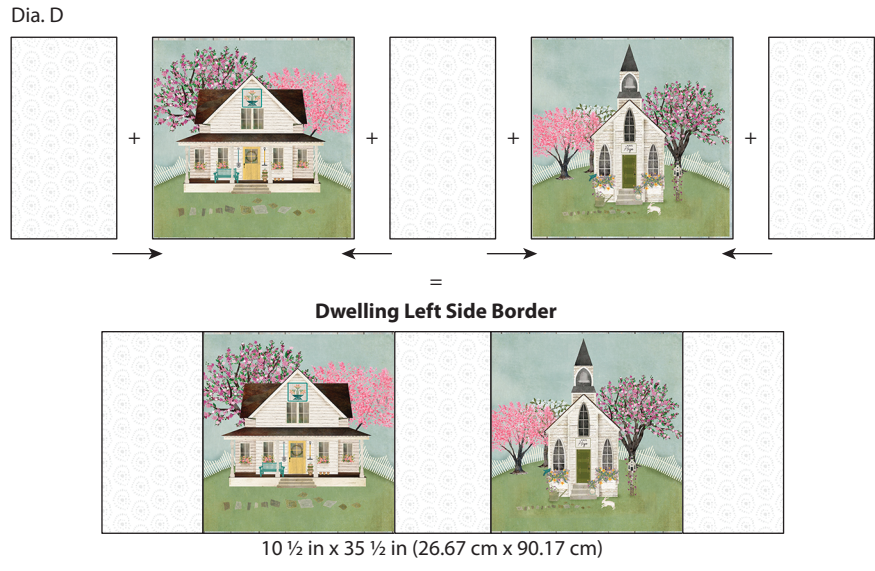

5. Follow Step 4 and Diagram E using three Circle Dots rectangles $5\frac{1}{2}$ in x $10\frac{1}{2}$ in (13.97 cm x 26.67 cm) and two Fussy Cut Dwelling Panel squares $10\frac{1}{2}$ in x $10\frac{1}{2}$ in (26.67 cm x 26.67 cm) as shown to make the Dwelling Right Side Border $10\frac{1}{2}$ in x $35\frac{1}{2}$ in (26.67 cm x 90.17 cm).

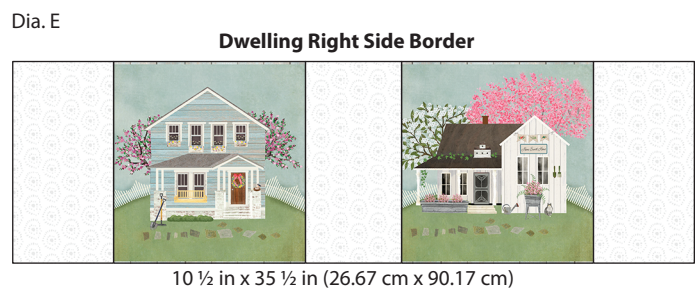

6. Follow Step 4 and Diagram F using three Circle Dots rectangles 5 ½ in x 10 ½ in (13.97 cm x 26.67 cm), two Fussy Cut Dwelling Panel squares 10 ½ in x 10 ½ in (26.67 cm x 26.67 cm) and two HST Units as shown to make the Dwelling Top Border 10 ½ in x 55 ½ in (26.67 cm x 104.97 cm); press.

Dia. F

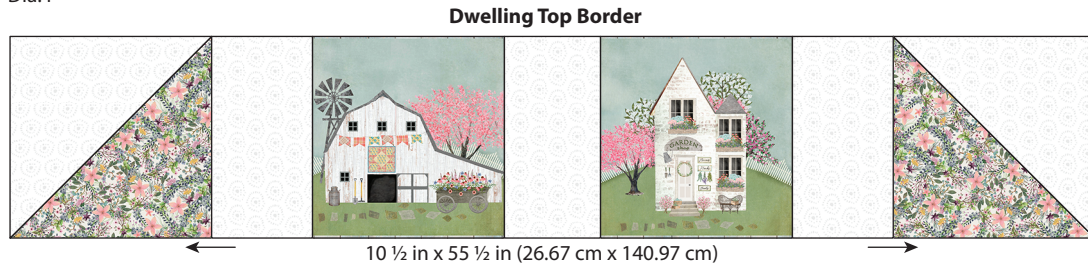

7. Follow Step 4 and Diagram G using three Circle Dots rectangles 5 ½ in x 10 ½ in (13.97 cm x 26.67 cm), two Fussy Cut Dwelling Panel squares 10 ½ in x 10 ½ in (26.67 cm x 26.67 cm) and two HST Units as shown to make the Dwelling Bottom Border 10 ½ in x 55 ½ in (26.67 cm x 140.97 cm).

Dia. G

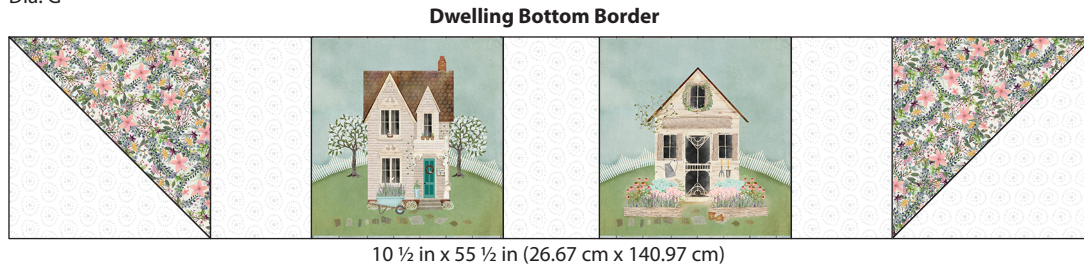

8. Place two Shelves strips 2 in x 28 in (5.08 cm x 71.12 cm) as shown in Diagram H. Pin RST, sew and press open to make the Shelves Side Border 2 in x 55 ½ in (5.08 cm x 140.97 cm). **Note:** Check orientation of design. Repeat to make two.

Dia. H

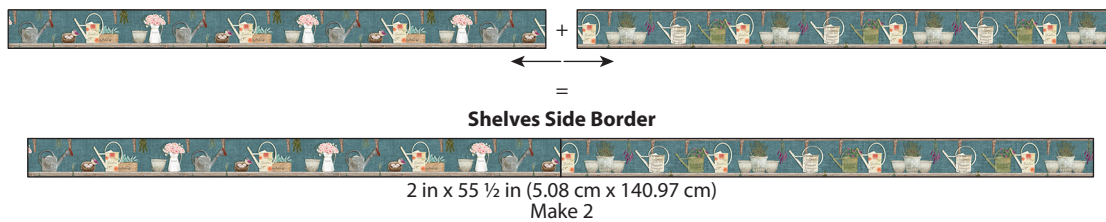

9. Follow Step 8 and Diagram I using four Shelves strips 2 in x 29 ½ in (5.08 cm x 74.93 cm) to make the Shelves Top and Bottom Borders 2 in x 58 ½ in (5.08 cm x 148.59 cm).

Dia. I

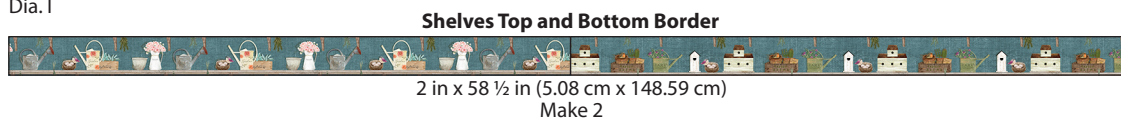

10. Place four Circle Dots, two Seed Packets and two Garden Tools squares $7\frac{3}{4}$ in x $7\frac{3}{4}$ in (19.69 cm x 19.69 cm) as shown in Diagram J. **Note:** Check orientation of design. Pin RST, sew and press away from the Circle Dots squares to make the Outer Left Side Border $7\frac{3}{4}$ in x $58\frac{1}{2}$ in (19.69 cm x 148.59 cm).

Dia. J

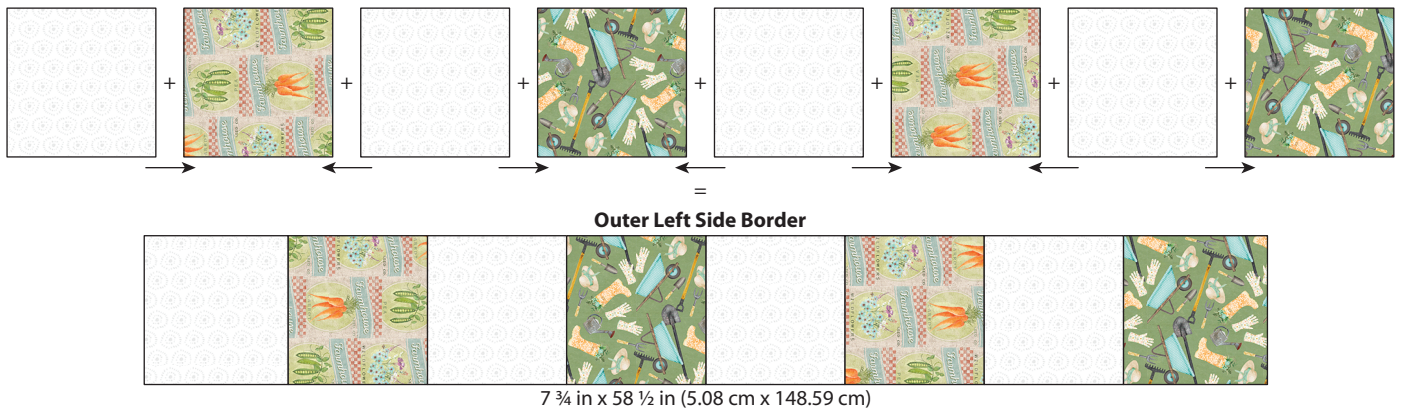

11. Follow Step 10 and Diagram K using four Circle Dots, two Seed Packets and two Garden Tools squares $7\frac{3}{4}$ in x $7\frac{3}{4}$ in (19.69 cm x 19.69 cm) as shown. Pin RST, sew and press to make the Outer Right Side Border $7\frac{3}{4}$ in x $58\frac{1}{2}$ in (19.69 cm x 148.59 cm).

Dia. K

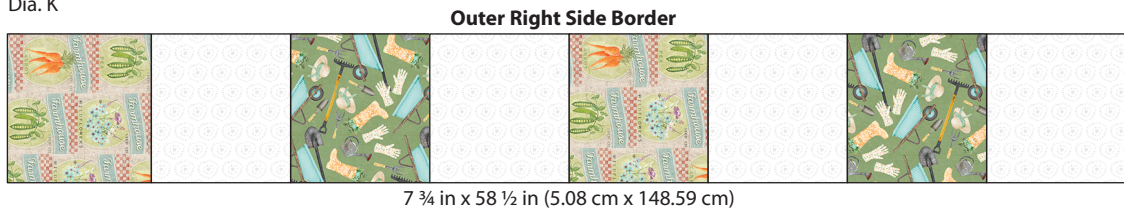

12. Follow Step 10 and Diagram L using five Circle Dots, three Seed Packets and two Garden Tools squares $7\frac{3}{4}$ in x $7\frac{3}{4}$ in (19.69 cm x 19.69 cm) as shown. Pin RST, sew and press to make the Outer Top Border $7\frac{3}{4}$ in x 73 in (19.69 cm x 185.42 cm).

Dia. L

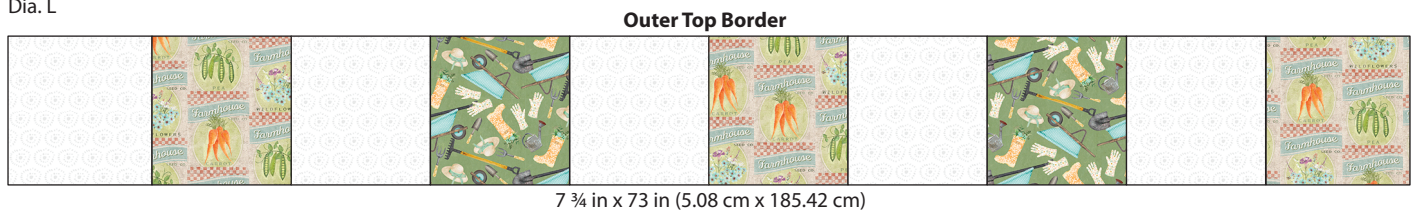

13. Follow Step 10 and Diagram M using five Circle Dots, two Seed Packets and three Garden Tools squares $7\frac{3}{4}$ in x $7\frac{3}{4}$ in (19.69 cm x 19.69 cm) as shown. Pin RST, sew and press to make the Outer Bottom Border $7\frac{3}{4}$ in x 73 in (19.69 cm x 185.42 cm).

Dia. M

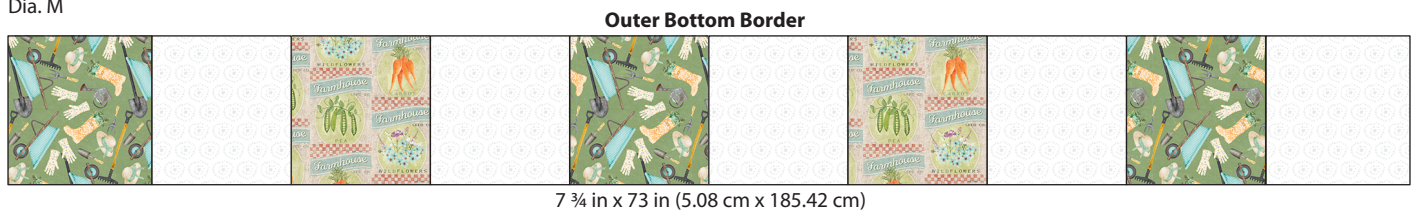

14. Refer to Diagram N to place the Borders around the Quilt Center 35 ½ in x 35 ½ in (90.17 cm x 90.17 cm). Sew each Border RST in the order listed. Pin matching center, seams and ends. Press seams as shown. Measure at each step to ensure the next border will fit. **Tip:** If one border is a little larger than the border it is being sewn to, pin well to ease the fullness and place the fullness on the bottom while sewing. Finished Quilt Top should measure 73 in x 73 in (185.42 cm x 185.42 cm).

Dwelling Border

Sides: Left and Right Side Borders 10 ½ in x 35 ½ in (26.67 cm x 90.17 cm); made in Steps 4 and 5
 Top and Bottom: Top and Bottom Borders 10 ½ in x 55 ½ in (26.67 cm x 140.97 cm); made in Steps 6 and 7
 Quilt Top - 55 ½ in x 55 ½ in (140.97 cm x 140.97 cm).

Shelves Border

Sides: 2 – Side Borders 2 in x 55 ½ in (5.08 cm x 140.97 cm); made in Step 8
 Top and Bottom: 2 – Top and Bottom Borders 2 in x 58 ½ in (5.08 cm x 148.59 cm); made in Step 9
 Quilt Top - 58 ½ in x 58 ½ in (148.59 cm x 148.59 cm).

Outer Border

Sides: Side Borders 7 ¾ in x 58 ½ in (19.69 cm x 148.59 cm); made in Steps 10 and 11
 Top and Bottom: Top and Bottom Borders 7 ¾ in x 73 in (19.69 cm x 185.42 cm); made in Steps 12 and 13
 Quilt Top - 73 in x 73 in (185.42 cm x 185.42 cm).

Dia. N

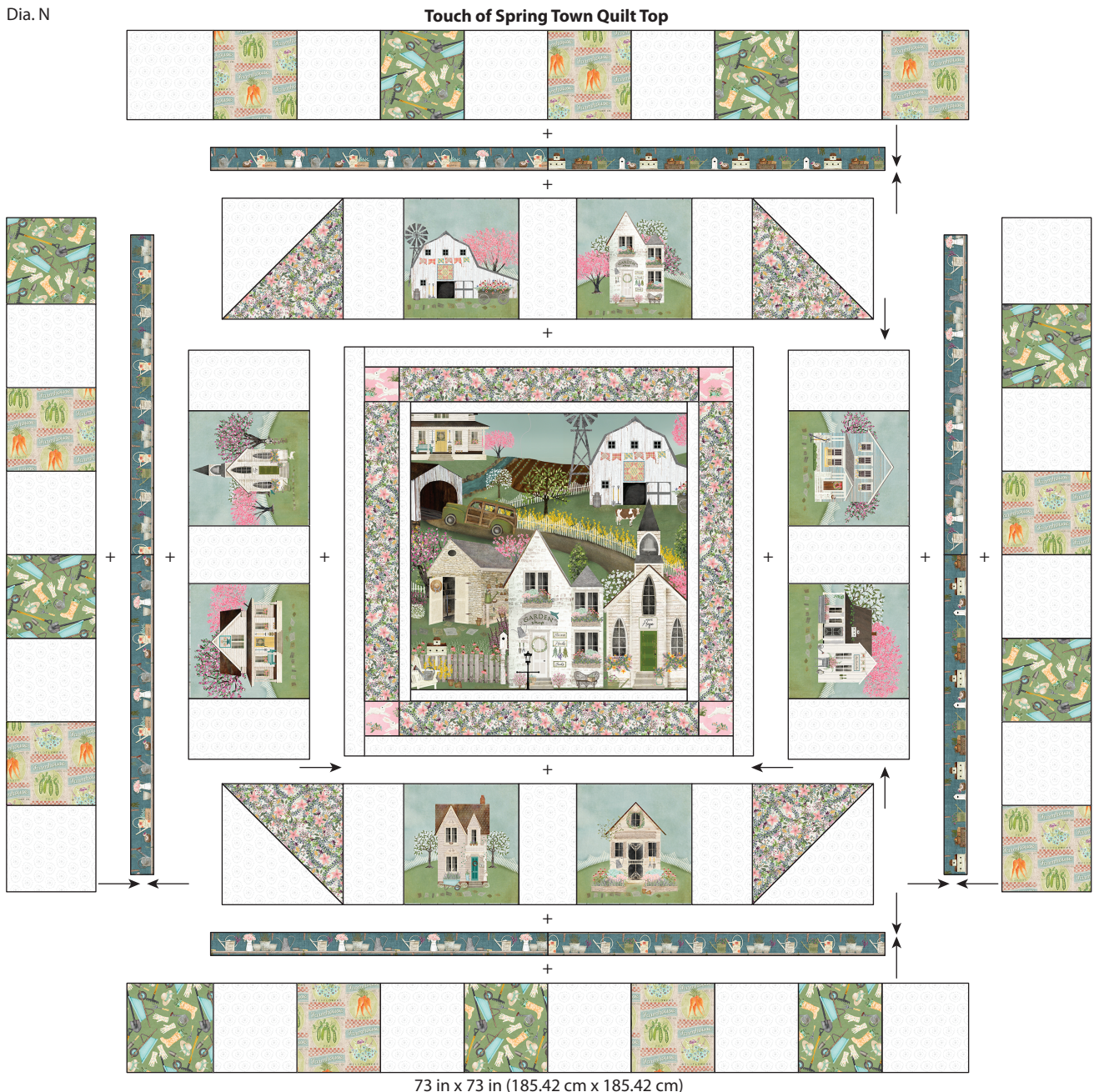

Finishing

- Remove the selvages from the Spring Patch Backing fabric.
Note: Check orientation of design. Cut two pieces $40\frac{3}{4}$ in x 81 in (103.51 cm x 205.74 cm). Pin the two sections RST and sew along the long edges as shown in Diagram O. Press the seam open or to one side. The Backing should measure 81 in x 81 in (205.74 cm x 205.74 cm).
- Press finished Quilt Top and Backing. Tape the Backing, **wrong** side up, to a firm surface. Layer Batting and Quilt Top (right side up). Baste the layers together with safety pins. Quilt as desired.
- Once quilting is complete, square up corners and edges, trimming excess Backing and Batting even with the Quilt Top.

Dia. O



Backing
81 in x 81 in (205.74 cm x 205.74 cm)

- Binding** – Follow Diagram P to make the Shelves Binding. Remove selvages and sew the short ends of the eight $2\frac{1}{2}$ in (6.35 cm) x wof strips RST end to end at a 45° angle to make one continuous strip; press seams open. Press one short end $\frac{1}{4}$ in (6.35 mm) to the **wrong** side. Fold in half lengthwise with **wrong** sides together; press. Leaving a 2 in (5.08 cm) tail on the folded end, place cut edges of folded Binding even with the edge of the Quilt Top and sew, mitering the corners. Overlap ends, trim any excess and finish sewing the Binding. Fold Binding over to back and hand stitch.

Dia. P

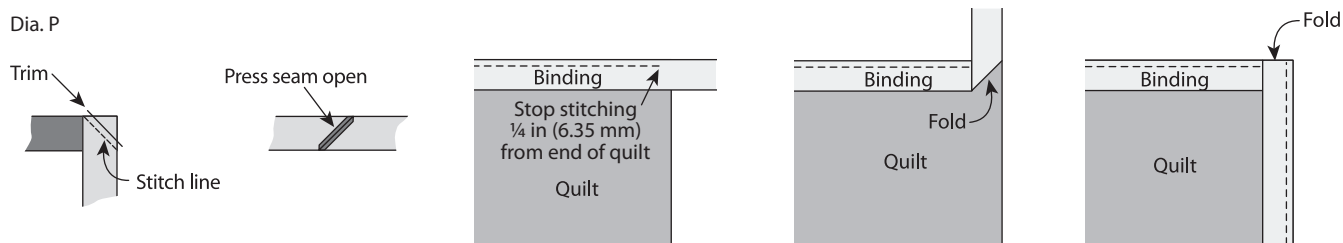

Finished Care Instructions

Machine wash in cold water; gentle cycle. Do not bleach. **Tip:** Before drying, check for fabric dyes that may have run. If fabric dyes run, rewash and rinse using a color catcher to absorb loose dye. Lay flat to dry or tumble dry low.