



Magical Galaxy Quilt



Finished Size: 72 ½" x 72 ½" (184.15cm x 184.15cm)

Fabric Needed

3 Wishes Fabric® Magical Galaxy Collection

- 2 ¾ yds – Sun & Moon (17164-WHT-CTN-D)
- 1 ¼ yds – Stars & Moons (17163-MLT-CTN-D)
- 1 yd – Stars (17162-MLT-CTN-D) for Piecing and Binding
- ¾ yd – Quora Sky (17165-PUR-CTN-D)
- ⅝ yd – Nautical Twilight (17168-TRQ-CTN-D)
- ⅝ yd – Civil Twilight (17169-BLU-CTN-D)
- ½ yd – Stars & Planets (17161-WHT-CTN-D)
- ½ yd – Fractured Twilight (17167-MLT-CTN-D)
- ⅜ yd – Airglow Sky (17166-GRN-CTN-D)
- 4 ½ yds – Celestial Charts (17160-MLT-CTN-D) for Backing – Directional

Additional Supplies Needed:

- 80" x 80" (203.2cm x 203.2cm) Cotton batting
- Piecing and sewing thread
- Quilting and sewing supplies
- Even-feed foot (optional for quilting)

Fabric collection ships to stores beginning January 2021.

Before You Begin

Read all instructions before beginning project. Do not pre-wash fabrics. Press fabrics with a dry iron on cotton setting before cutting. Use a 1/4" (6.35mm) seam allowance and sew fabrics with right sides together (RST) unless otherwise noted. Press seams in the direction of the arrows. wof = width of fabric

Cutting

Use a rotary cutter and ruler to cut the size and number of pieces from each fabric listed below. Organize and label pieces with baggies, paper plates or clips.

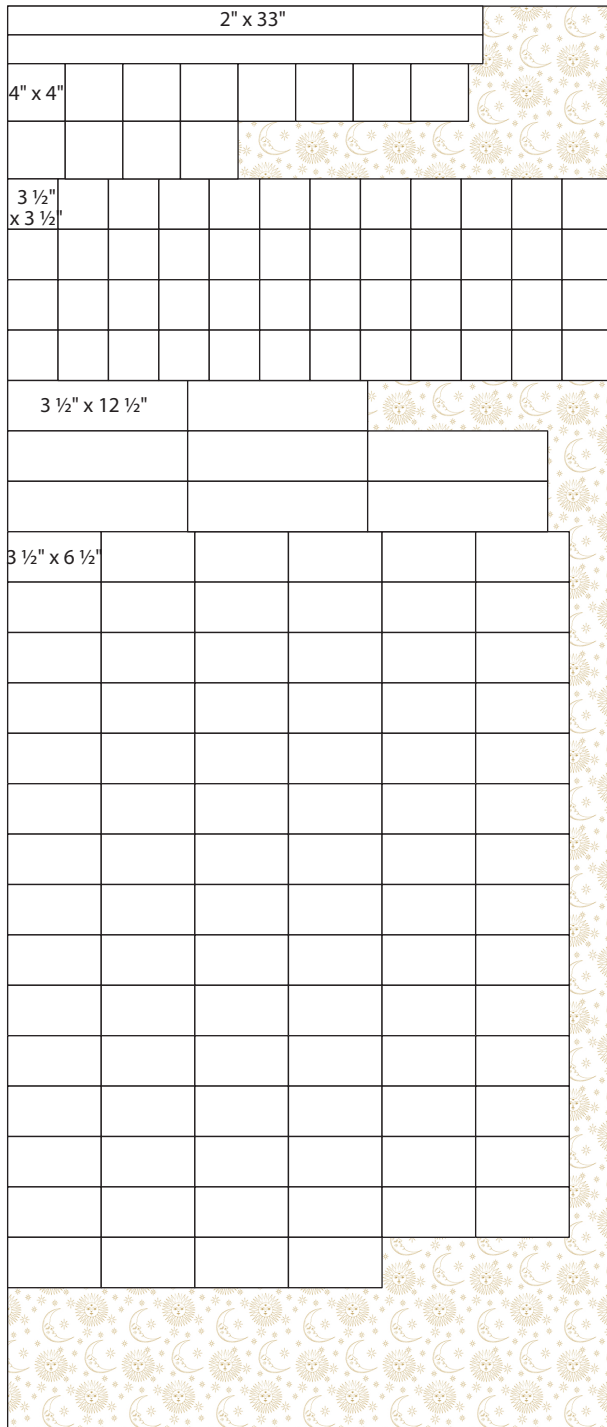

Sun & Moon – 17164-WHT-CTN-D
(2 3/4 yds x wof / 251.46cm x 106.68cm)
 Cut 2 – 2" x 33" (5.08cm x 83.82cm)
 Cut 12 – 4" x 4" (10.16cm x 10.16cm)
 Cut 48 – 3 1/2" x 3 1/2" (8.89cm x 8.89cm)
 Cut 8 – 3 1/2" x 12 1/2" (8.89cm x 31.75cm)
 Cut 88 – 3 1/2" x 6 1/2" (8.89cm x 16.51cm)

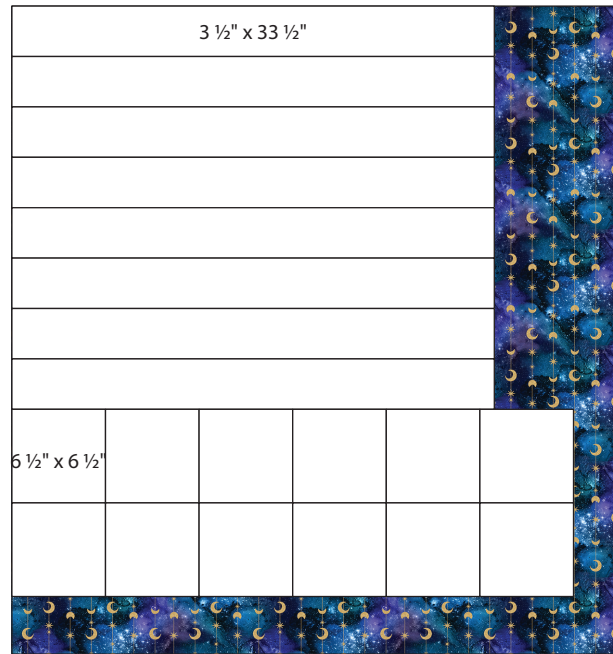

Stars & Moons – 17163-MLT-CTN-D
(1 1/4 yds x wof / 114.3cm x 106.68cm)
 Cut 8 – 3 1/2" x 33 1/2" (8.89cm x 85.09cm)
 Cut 12 – 6 1/2" x 6 1/2" (16.51cm x 16.51cm)

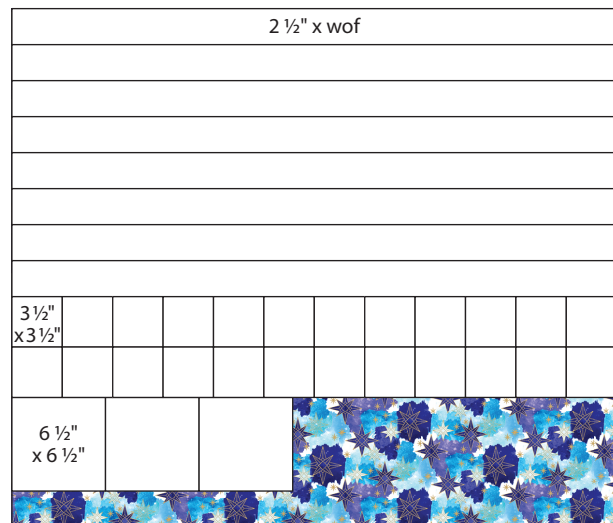

Stars – 17162-MLT-CTN-D (1 yd x wof / 91.44cm x 106.68cm)
 Cut 8 – 2 1/2" x wof (6.35cm x 106.68cm) for Binding
 Cut 24 – 3 1/2" x 3 1/2" (8.89cm x 8.89cm)
 Cut 3 – 6 1/2" x 6 1/2" (16.51cm x 16.51cm)

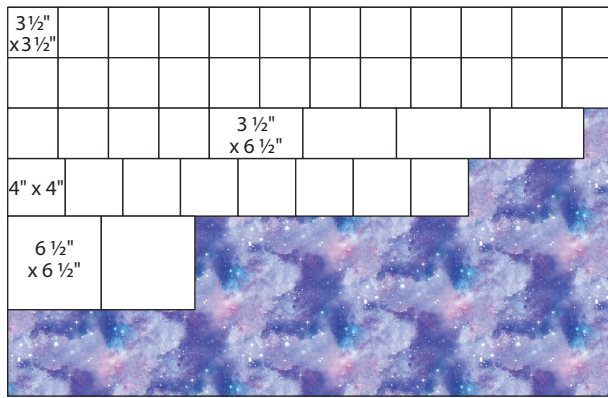

Quora Sky – 17165-PUR-CTN-D (3/4 yd x wof / 68.58cm x 106.68cm)
 Cut 28 – 3 1/2" x 3 1/2" (8.89cm x 8.89cm)
 Cut 4 – 3 1/2" x 6 1/2" (8.89cm x 16.51cm)
 Cut 8 – 4" x 4" (10.16cm x 10.16cm)
 Cut 2 – 6 1/2" x 6 1/2" (16.51cm x 16.51cm)

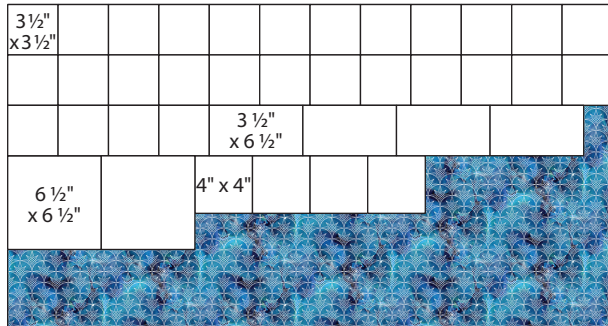

Nautical Twilight – 17168-TRQ-CTN-D (5/8 yd x wof / 57.15cm x 106.68cm)
 Cut 28 – 3 1/2" x 3 1/2" (8.89cm x 8.89cm)
 Cut 4 – 3 1/2" x 6 1/2" (8.89cm x 16.51cm)
 Cut 2 – 6 1/2" x 6 1/2" (16.51cm x 16.51cm)
 Cut 4 – 4" x 4" (10.16cm x 10.16cm)

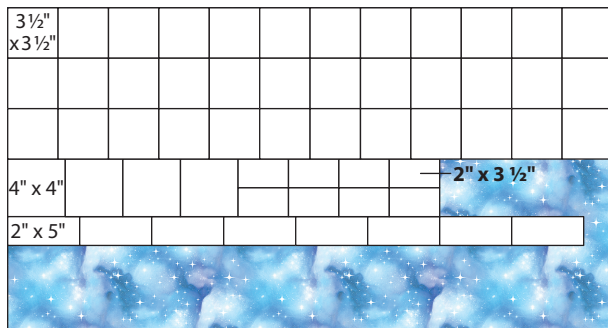

Civil Twilight – 17169-BLU-CTN-D (5/8 yd x wof / 57.15cm x 106.68cm)
 Cut 36 – 3 1/2" x 3 1/2" (8.89cm x 8.89cm)
 Cut 4 – 4" x 4" (10.16cm x 10.16cm)
 Cut 8 – 2" x 3 1/2" (5.08cm x 8.89cm)
 Cut 8 – 2" x 5" (5.08cm x 12.7cm)

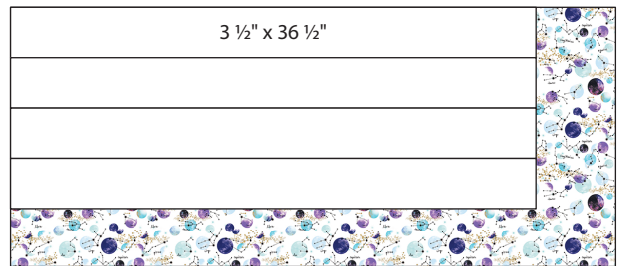

Stars & Planets – 17161-WHT-CTN-D (1/2 yd x wof / 45.72cm x 106.68cm)
 Cut 4 – 3 1/2" x 36 1/2" (8.89cm x 92.71cm)

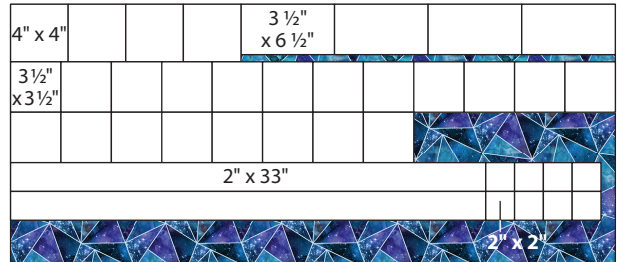

Fractured Twilight – 17167-MLT-CTN-D (1/2 yd x wof / 45.72cm x 106.68cm)
 Cut 4 – 4" x 4" (10.16cm x 10.16cm)
 Cut 20 – 3 1/2" x 3 1/2" (8.89cm x 8.89cm)
 Cut 4 – 3 1/2" x 6 1/2" (8.89cm x 16.51cm)
 Cut 2 – 2" x 33" (5.08cm x 83.82cm)
 Cut 8 – 2" x 2" (5.08cm x 5.08cm)

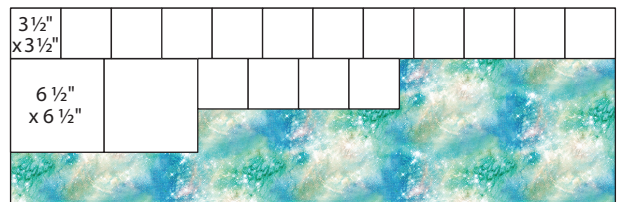

Airglow Sky – 17166-GRN-CTN-D (3/8 yd x wof / 34.29cm x 106.68cm)
 Cut 16 – 3 1/2" x 3 1/2" (8.89cm x 8.89cm)
 Cut 2 – 6 1/2" x 6 1/2" (16.51cm x 16.51cm)

Sewing

Keep Units organized and labeled as they are made using baggies, paper plates or clips.

1. Refer to Diagram A to make the Half-Square Triangle (HST) Units. **Note:** Two squares yield two HST Units. Draw a diagonal line on the **wrong** side of a Sun & Moon square (4" x 4" / 10.16cm x 10.16cm). Place the Sun & Moon square on top of a Civil Twilight square (4" x 4" / 10.16cm x 10.16cm) with RST and sew $\frac{1}{4}$ " (6.35mm) away from the line on both sides. Cut on the drawn line; press. Repeat to make a total of eight Sun & Moon/Civil Twilight HST Units (3 $\frac{1}{2}$ " x 3 $\frac{1}{2}$ " / 8.89cm x 8.89cm). Square up and trim if necessary.

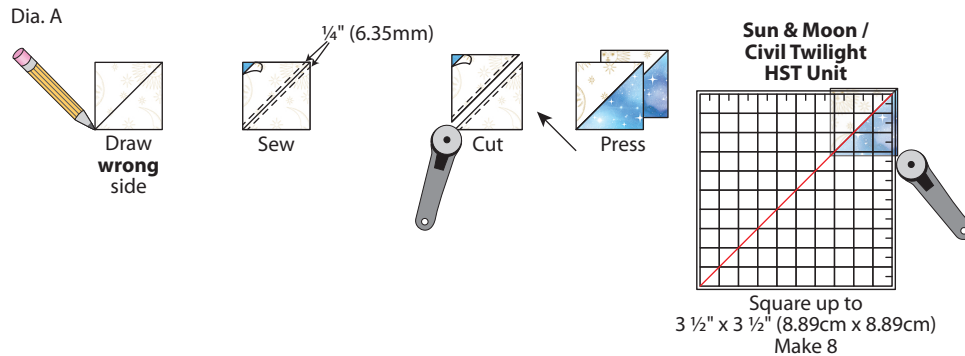

Repeat to make the following HST Units (3 $\frac{1}{2}$ " x 3 $\frac{1}{2}$ " / 8.89cm x 8.89cm) shown below in Diagram B. Make eight of each.

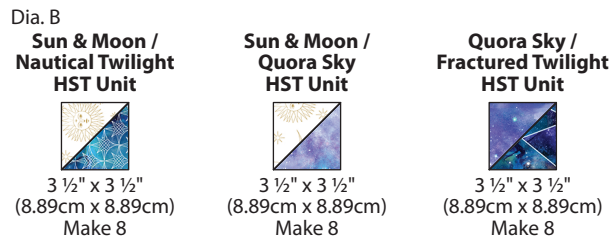

2. Refer to Diagram C to make the Flying Geese (FG) Units. Draw a diagonal line on the **wrong** side of two Sun & Moon squares (3 $\frac{1}{2}$ " x 3 $\frac{1}{2}$ " / 8.89cm x 8.89cm). Place RST on the left side of a Quora Sky rectangle (3 $\frac{1}{2}$ " x 6 $\frac{1}{2}$ " / 8.89cm x 16.51cm). Sew on the diagonal line and trim seam to $\frac{1}{4}$ " (6.35mm); press. Place the other Sun & Moon square (3 $\frac{1}{2}$ " x 3 $\frac{1}{2}$ " / 8.89cm x 8.89cm) on the right side of the rectangle; sew and press to make one Sun & Moon/Quora Sky FG Unit (3 $\frac{1}{2}$ " x 6 $\frac{1}{2}$ " / 8.89cm x 16.51cm). Repeat to make four.

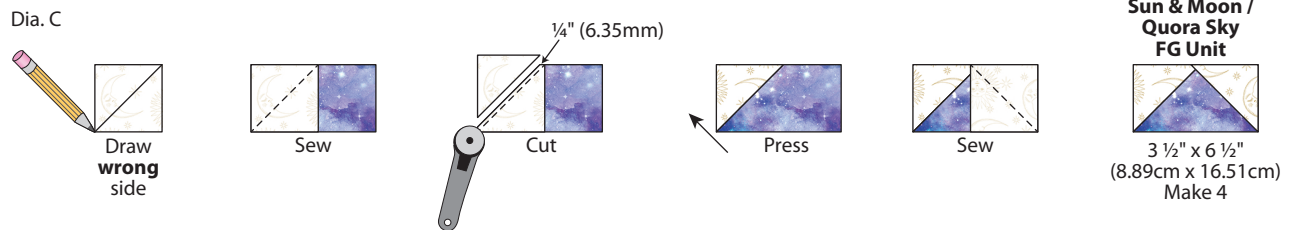

Repeat to make the following FG Units (3 $\frac{1}{2}$ " x 6 $\frac{1}{2}$ " / 8.89cm x 16.51cm) shown below in Diagram D. **Note:** Refer to Diagram for the number of each.

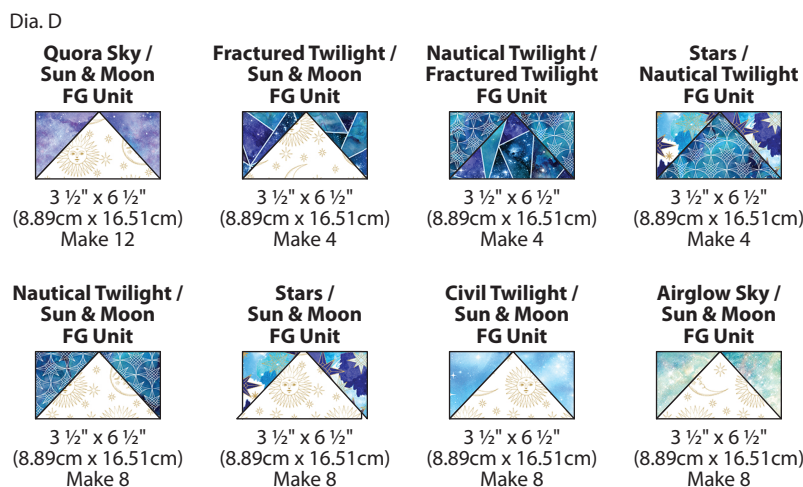

3. Use the following strip piecing method to minimize working with small pieces. Place the Sun & Moon and Fractured Twilight strips (2" x 33" / 5.08cm x 83.82cm) as shown in Diagram E. Pin RST, sew and press. The strip set should measure 3 1/2" x 33" / 8.89cm x 83.82cm. Repeat to sew two pairs. Straighten one end and cut 16 Strip Set Units (2" x 3 1/2" / 5.08cm x 8.89cm) from each pair for a total of 32 Strip Set Units.

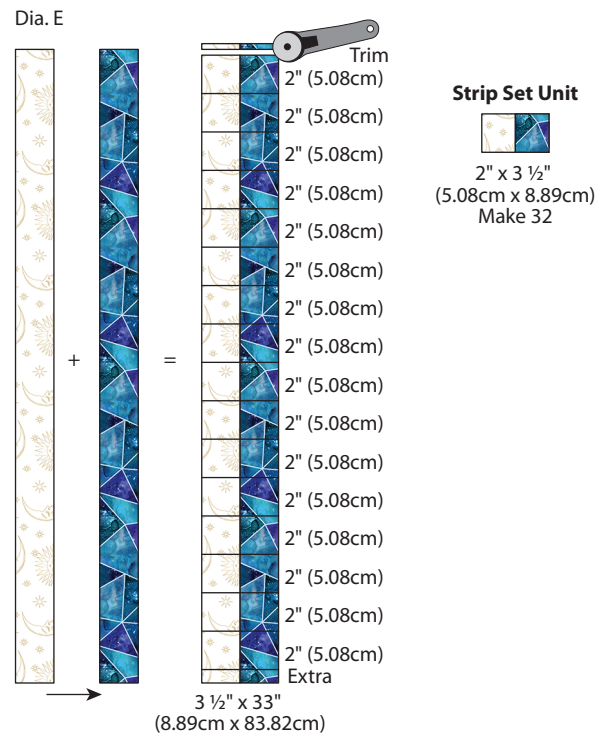

4. Place two Strip Set Units in two rows as shown in Diagram F. Pin RST matching seams, sew and press open to make one Four-Square Unit (3 1/2" x 3 1/2" / 8.89cm x 8.89cm). Make 16.

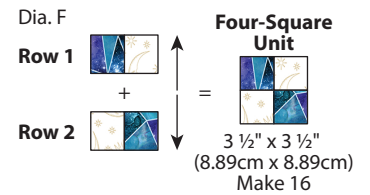

5. Place one Sun & Moon rectangle (3 1/2" x 6 1/2" / 8.89cm x 16.51cm) and one Sun & Moon/Civil Twilight HST Unit (3 1/2" x 3 1/2" / 8.89cm x 8.89cm) as shown in Diagram G. Pin RST, sew and press to make Triangle Unit 1 (3 1/2" x 9 1/2" / 8.89cm x 24.13cm). Make four. Repeat to make four mirror image Triangle Unit 2. **Note:** Check the orientation of the HST Unit.

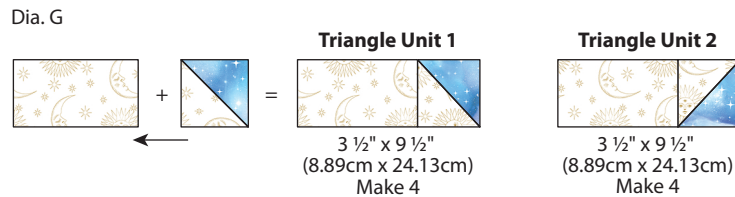

6. Place one Nautical Twilight and two Fractured Twilight squares (3 1/2" x 3 1/2" / 8.89cm x 8.89cm) with two Sun & Moon/Nautical Twilight, two Sun & Moon/Quora Sky and two Quora Sky/Fractured Twilight HST Units (3 1/2" x 3 1/2" / 8.89cm x 8.89cm) in three rows as shown in Diagram H. Pin the squares and Units in each row RST, sew and press. Pin the rows RST matching seams, sew and press to make one Corner Unit (9 1/2" x 9 1/2" / 24.13cm x 24.13cm). Make four.

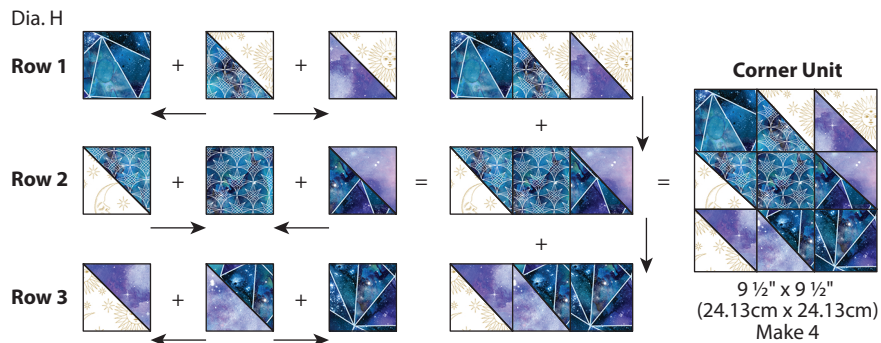

7. Place the Corner Unit (9 1/2" x 9 1/2" / 24.13cm x 24.13cm), one Triangle Unit 1, one Triangle Unit 2 (3 1/2" x 6 1/2" / 8.89cm x 16.51cm), and a Civil Twilight square (3 1/2" x 3 1/2" / 8.89cm x 8.89cm) in two rows as shown in Diagram I. Pin the rows RST matching seams, sew and press to make one Quadrant Unit (12 1/2" x 12 1/2" / 31.75cm x 31.75cm). Make four.

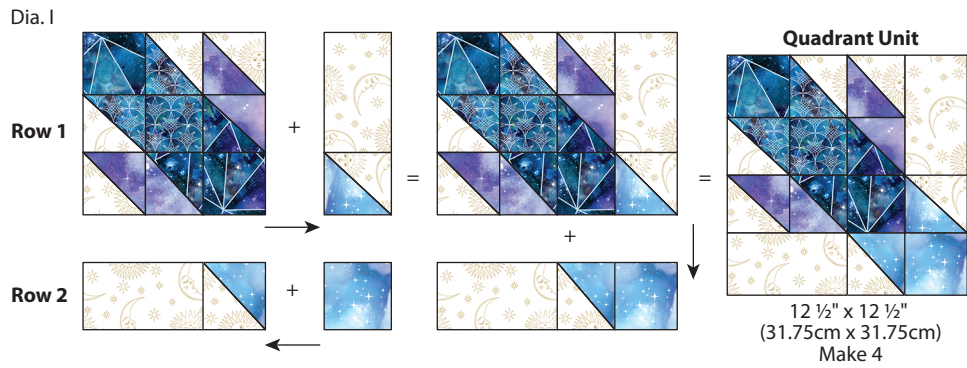

8. Place a Sun & Moon/Quora Sky, Fractured Twilight/Sun & Moon, Nautical Twilight/Fractured Twilight, and Stars/Nautical Twilight FG Unit (3 1/2" x 6 1/2" / 8.89cm x 16.51cm) as shown in Diagram J. Pin RST, sew and press to make one FG Row (6 1/2" x 12 1/2" / 16.51cm x 31.75cm). Make four.

Tip: Keep sharp triangle points by pinning and sewing just above the "X" intersection.

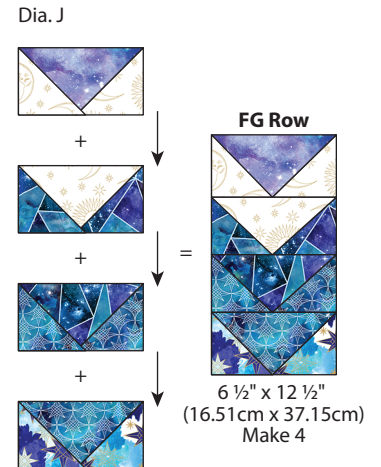
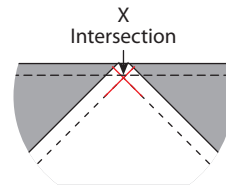

9. Place four Quadrant Units (12 1/2" x 12 1/2" / 31.75cm x 31.75cm), four FG Rows (6 1/2" x 12 1/2" / 16.51cm x 31.75cm) and one Stars square (6 1/2" x 6 1/2" / 16.51cm x 16.51cm) in three rows as shown in Diagram K. Pin the square and Units in each row RST matching seams, sew and press. Pin the rows RST matching seams, sew and press to make the Center Unit (30 1/2" x 30 1/2" / 77.47cm x 77.47cm).

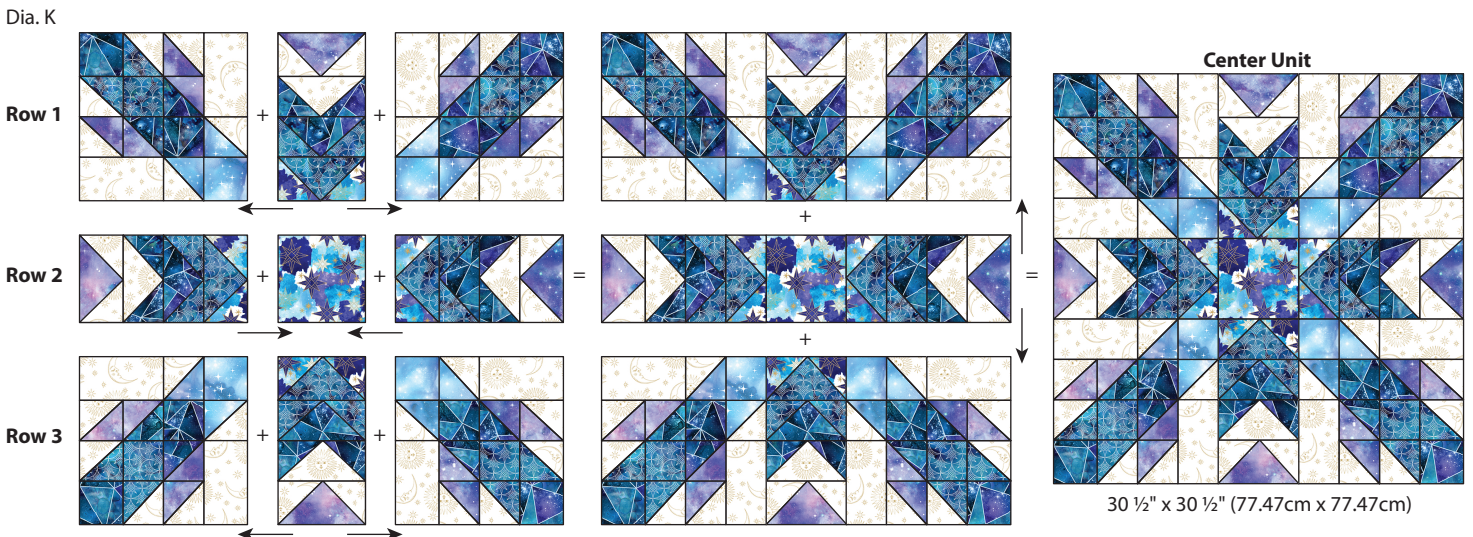

10. Place a Sun & Moon rectangle (3 1/2" x 12 1/2" / 8.89cm x 31.75cm) on each side of a Quora Sky/Sun & Moon FG Unit (3 1/2" x 6 1/2" / 8.89cm x 16.51cm) as shown in Diagram L. Pin RST, sew and press to make Border 1 Unit (3 1/2" x 30 1/2" / 16.51cm x 77.47cm). Make four.



11. Place a Four-Square Unit ($3\frac{1}{2}'' \times 3\frac{1}{2}'' / 8.89\text{cm} \times 8.89\text{cm}$) on each side of a Border 1 Unit as shown in Diagram M. Pin RST, sew and press to make the Top Border 1 ($3\frac{1}{2}'' \times 36\frac{1}{2}'' / 8.89\text{cm} \times 92.71\text{cm}$). Repeat to make the Bottom Border 1.

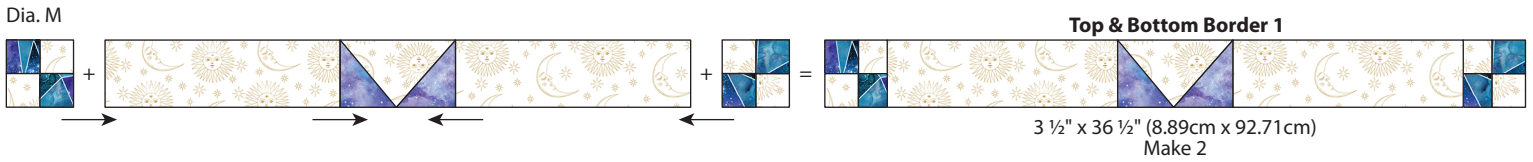

12. Place a Four-Square Unit ($3\frac{1}{2}'' \times 3\frac{1}{2}'' / 8.89\text{cm} \times 8.89\text{cm}$) on each side of a Stars & Planets rectangle ($3\frac{1}{2}'' \times 36\frac{1}{2}'' / 8.89\text{cm} \times 92.71\text{cm}$) as shown in Diagram N. Pin RST, sew and press to make the Top Border 2 ($3\frac{1}{2}'' \times 42\frac{1}{2}'' / 8.89\text{cm} \times 107.95\text{cm}$). Repeat to make the Bottom Border 2.

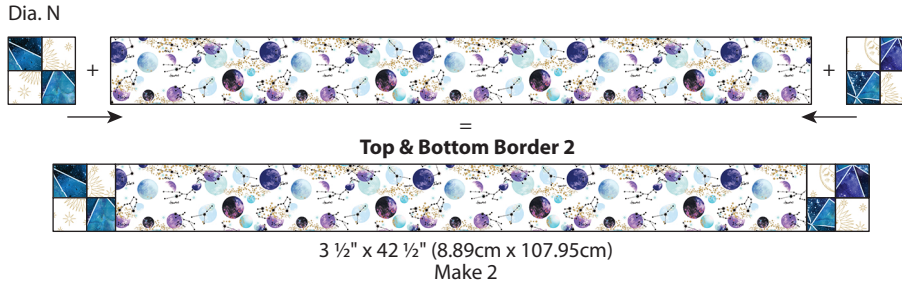

13. Place the Center Unit ($30\frac{1}{2}'' \times 30\frac{1}{2}'' / 77.47\text{cm} \times 77.47\text{cm}$) and Borders 1 and 2 as shown in Diagram O. Pin RST, sew and press. The Quilt Center should measure $42\frac{1}{2}'' \times 42\frac{1}{2}'' / 107.95\text{cm} \times 107.95\text{cm}$.

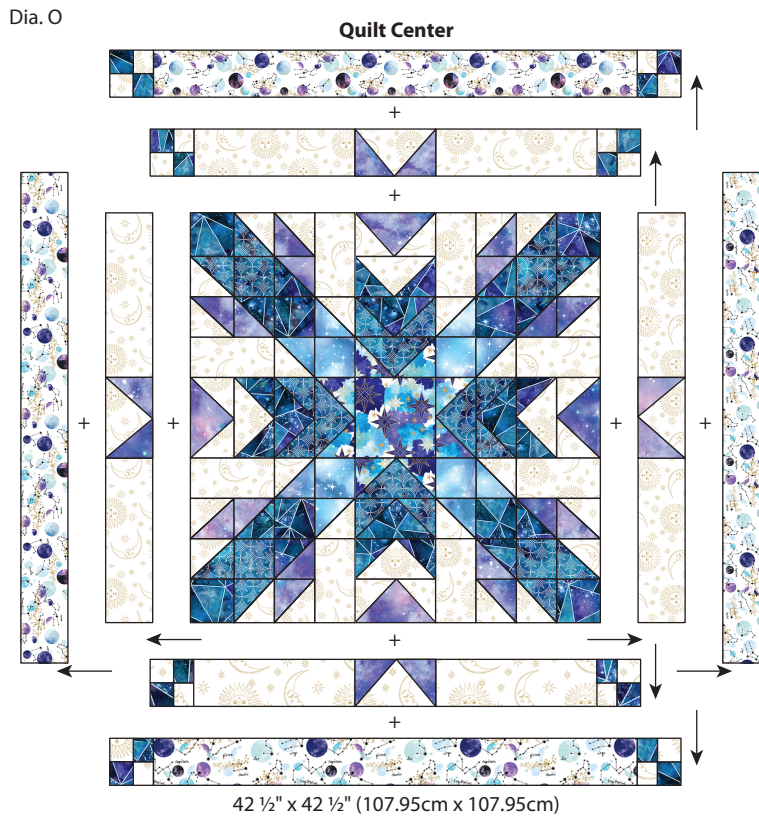

14. Place a Sun & Moon rectangle ($3\frac{1}{2}'' \times 6\frac{1}{2}'' / 8.89\text{cm} \times 16.51\text{cm}$) on each side of a Stars & Moons square ($6\frac{1}{2}'' \times 6\frac{1}{2}'' / 16.51\text{cm} \times 16.51\text{cm}$) as shown in Diagram P. Pin RST, sew and press to make a Border 3 Unit ($6\frac{1}{2}'' \times 12\frac{1}{2}'' / 16.51\text{cm} \times 31.75\text{cm}$). Make 12. **Note:** Check the orientation of the fabric design.

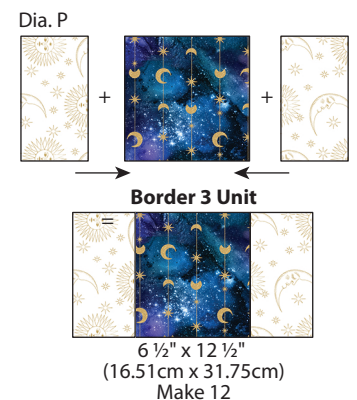

15. Place a Fractured Twilight square (3 1/2" x 3 1/2" / 8.89cm x 8.89cm), two Fractured Twilight squares (2" x 2" / 5.08cm x 5.08cm), two Civil Twilight rectangles (2" x 3 1/2" / 5.08cm x 8.89cm) and two Civil Twilight rectangles (2" x 5" / 5.08cm x 12.7cm) in three rows as shown in Diagram Q. Pin the squares and rectangles in each row RST, sew and press. Pin the rows RST matching seams, sew and press to make one Star Center Unit (6 1/2" x 6 1/2" / 16.51cm x 16.51cm). Make four.

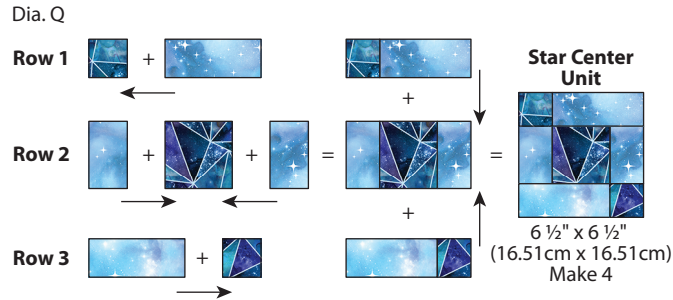

16. Place two Sun & Moon squares (3 1/2" x 3 1/2" / 8.89cm x 8.89cm), two Four-Square Units (3 1/2" x 3 1/2" / 8.89cm x 8.89cm), four Civil Twilight/Sun & Moon FG Units (3 1/2" x 6 1/2" / 8.89cm x 16.51cm) and the Star Center Unit (6 1/2" x 6 1/2" / 16.51cm x 16.51cm) in three rows as shown in Diagram R. Pin the squares and Units in each row RST, sew and press. Pin the rows RST matching seams, sew and press to make one Civil Twilight Star Block (12 1/2" x 12 1/2" / 31.75cm x 31.75cm). Make four.

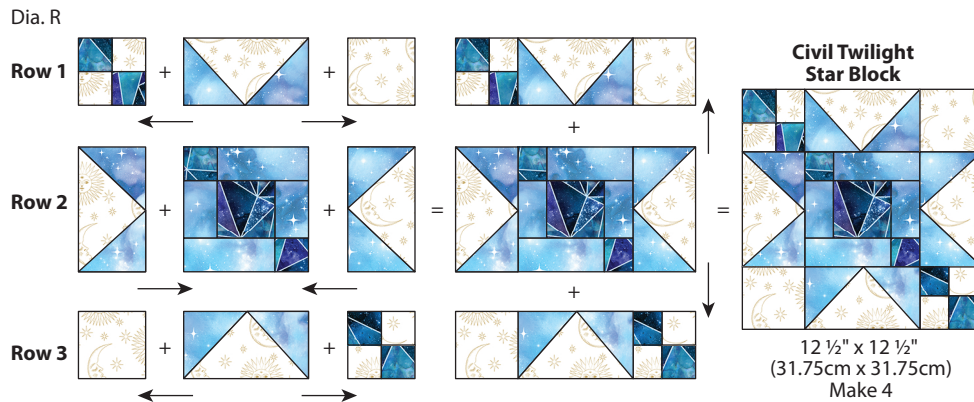

17. Place four Sun & Moon squares (3 1/2" x 3 1/2" / 8.89cm x 8.89cm), four Airglow Sky/Sun & Moon FG Units (3 1/2" x 6 1/2" / 8.89cm x 16.51cm) and one Airglow Sky square (6 1/2" x 6 1/2" / 16.51cm x 16.51cm) in three rows as shown in Diagram S. Pin the squares and Units in each row RST, sew and press. Pin the rows RST matching seams, sew and press to make one Airglow Sky Star Block (12 1/2" x 12 1/2" / 31.75cm x 31.75cm). Make two.

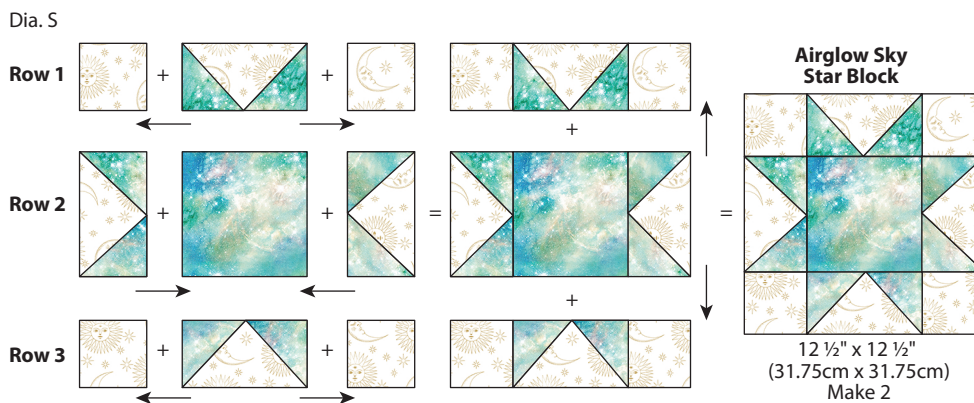

Repeat to make the following Star Blocks (12 1/2" x 12 1/2" / 31.75cm x 31.75cm) shown below in Diagram T.

Dia. T

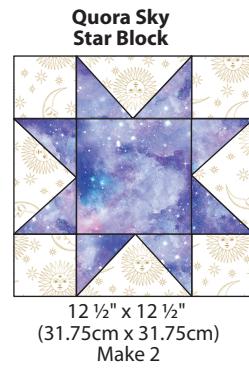

18. Place three Border 3 Units (6 1/2" x 12 1/2" / 16.51cm x 31.75cm), a Nautical Twilight Star Block and a Stars Star Block (12 1/2" x 12 1/2" / 31.75cm x 31.75cm) as shown in Diagram U. Pin RST, sew and press to make the Left Side Border 3 (12 1/2" x 42 1/2" / 31.75cm x 107.95cm).

Dia. U

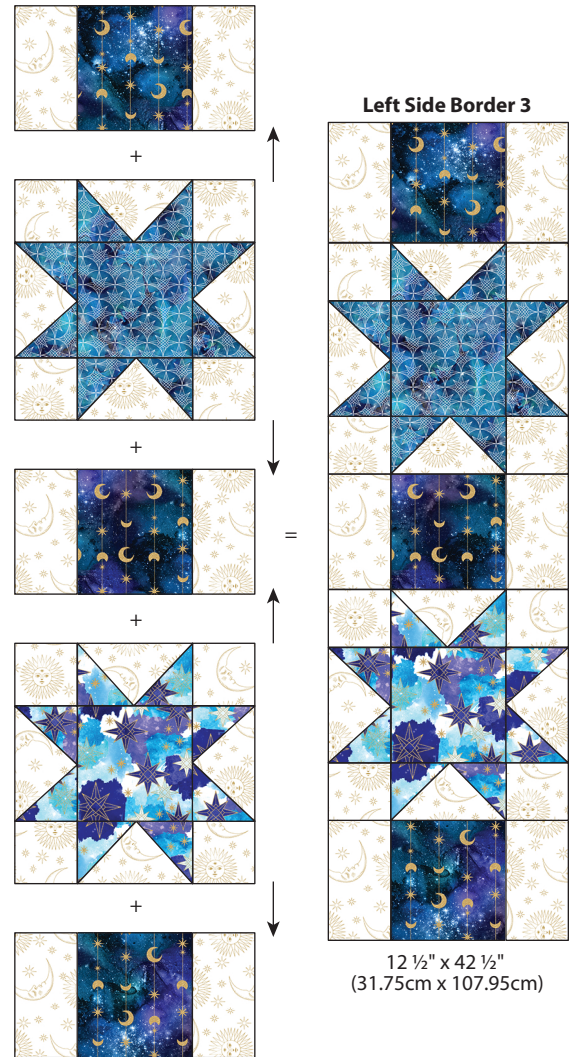

Place three Border 3 Units (6 1/2" x 12 1/2" / 16.51cm x 31.75cm), a Stars Star Block and a Quora Sky Star Block (12 1/2" x 12 1/2" / 31.75cm x 31.75cm) as shown in Diagram V. Pin RST, sew and press to make the Right Side Border 3 (12 1/2" x 42 1/2" / 31.75cm x 107.95cm).

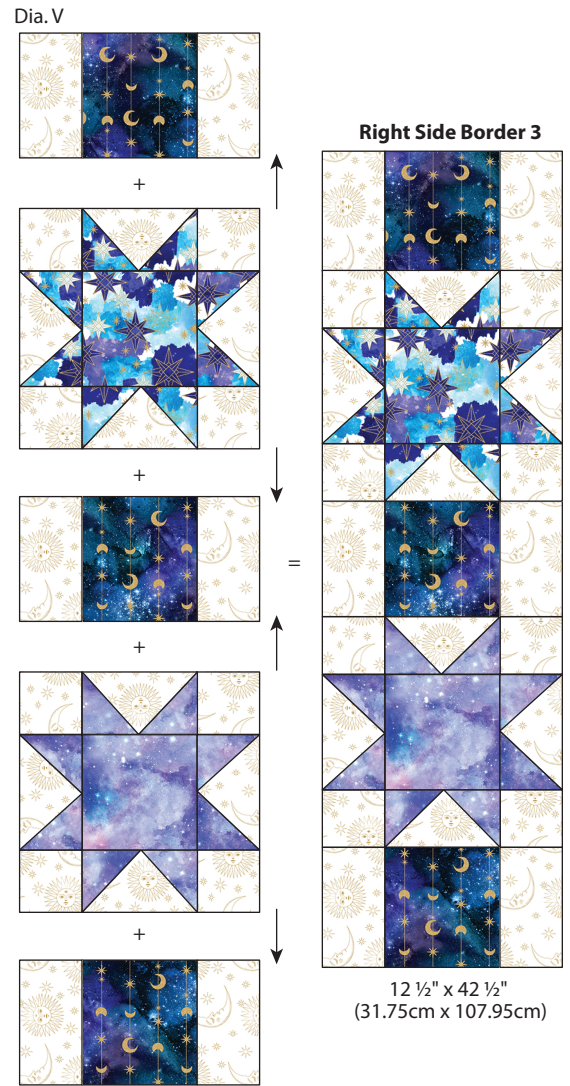

19. Place three Border 3 Units (6 1/2" x 12 1/2" / 16.51cm x 31.75cm), two Civil Twilight Star Blocks, an Airglow Sky Star Block and a Nautical Twilight Star Block (12 1/2" x 12 1/2" / 31.75cm x 31.75cm) as shown in Diagram W. Pin RST, sew and press to make the Top Border 3 (12 1/2" x 66 1/2" / 31.75cm x 168.91cm).

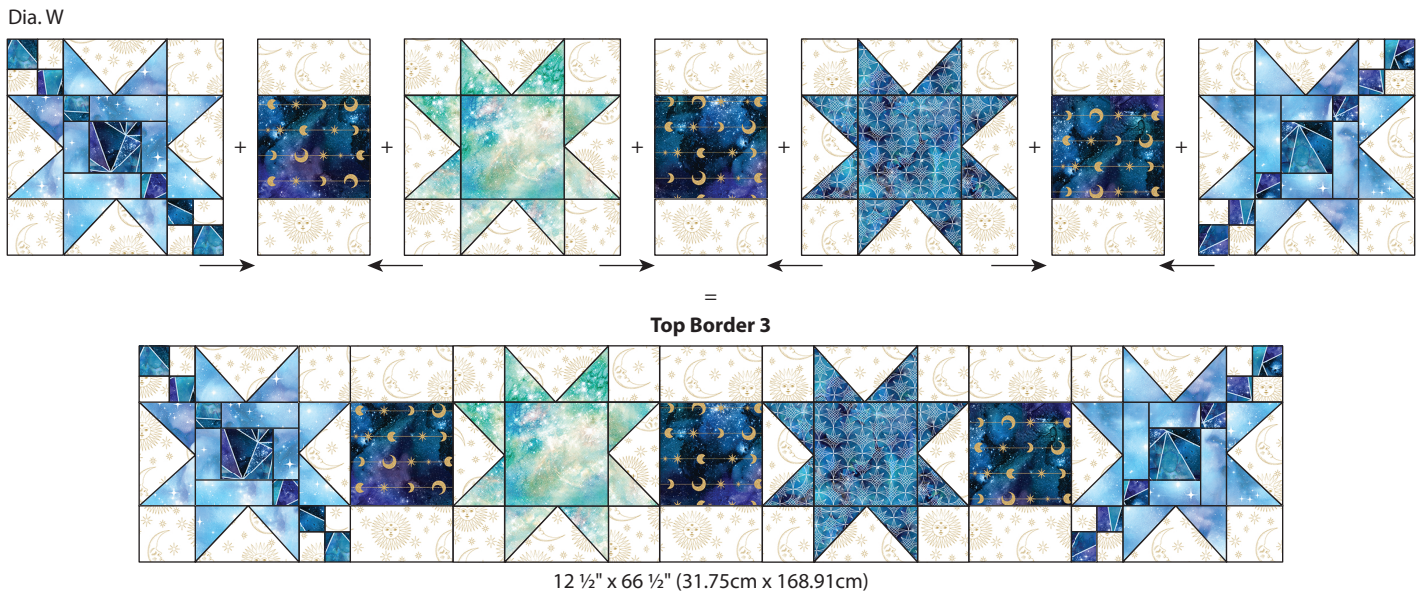

20. Place three Border 3 Units ($6\frac{1}{2}'' \times 12\frac{1}{2}'' / 16.51\text{cm} \times 31.75\text{cm}$), two Civil Twilight Star Blocks, a Quora Sky Star Block and an Airglow Sky Star Block ($12\frac{1}{2}'' \times 12\frac{1}{2}'' / 31.75\text{cm} \times 31.75\text{cm}$) as shown in Diagram X. Pin RST, sew and press to make the Bottom Border 3 ($12\frac{1}{2}'' \times 66\frac{1}{2}'' / 31.75\text{cm} \times 168.91\text{cm}$).

Dia. X

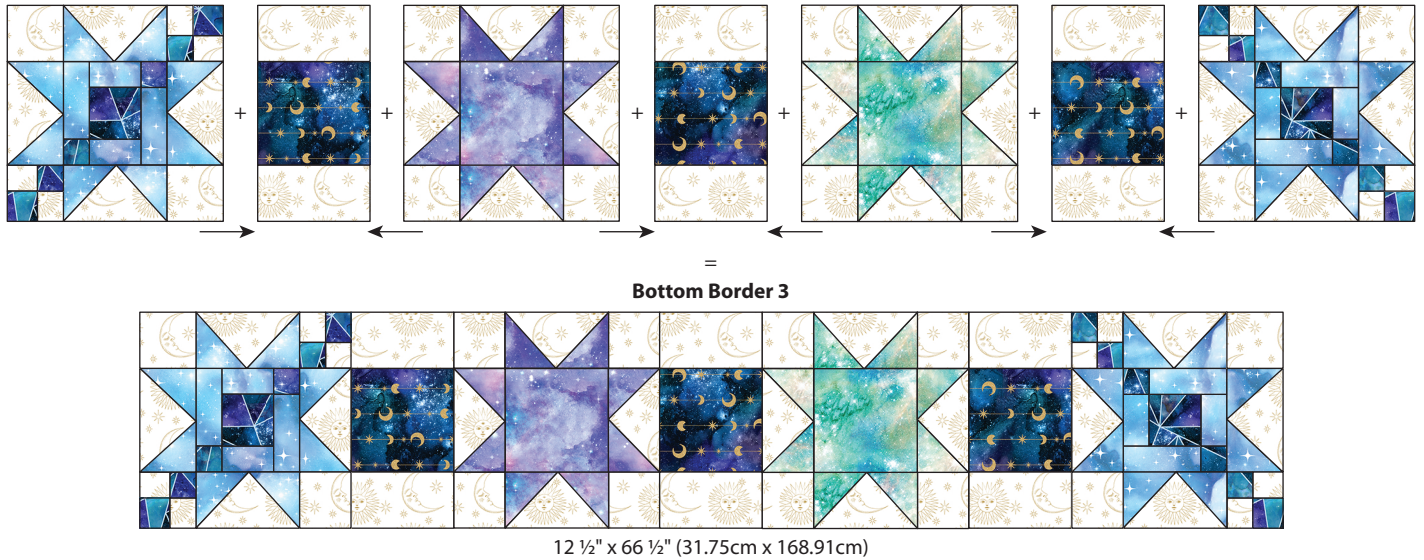

21. Place two Stars & Moons rectangles ($3\frac{1}{2}'' \times 33\frac{1}{2}'' / 8.89\text{cm} \times 85.09\text{cm}$) as shown in Diagram Y. Pin RST on the short ends, sew and press to make the Border 4 Unit ($3\frac{1}{2}'' \times 66\frac{1}{2}'' / 8.89\text{cm} \times 168.91\text{cm}$). Make four.

Dia. Y

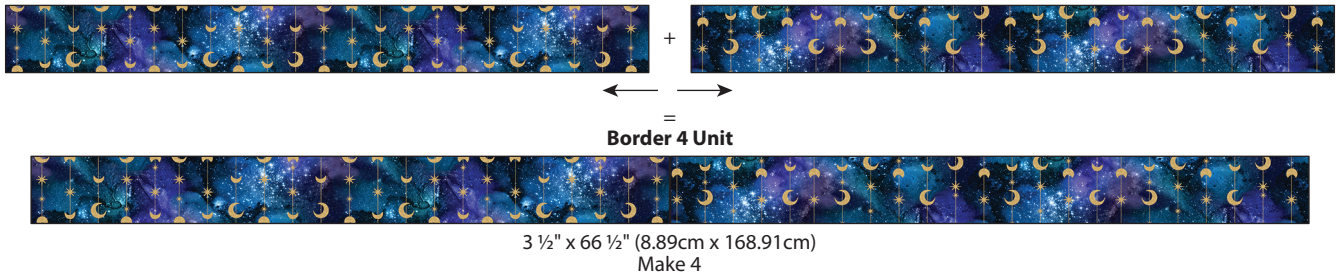

22. Place a Quora Sky square ($3\frac{1}{2}'' \times 3\frac{1}{2}'' / 8.89\text{cm} \times 8.89\text{cm}$) on each end of a Border 4 Unit as shown in Diagram Z. Pin RST, sew and press to make the Top Border 4 ($3\frac{1}{2}'' \times 72\frac{1}{2}'' / 8.89\text{cm} \times 184.15\text{cm}$). Repeat to make the Bottom Border 4.

Dia. Z

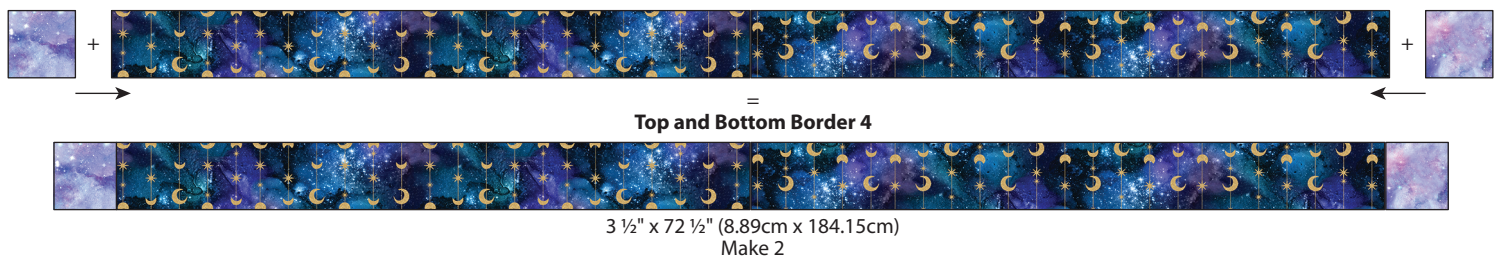

23. Place the Quilt Center (42 1/2" x 42 1/2" / 107.95cm x 107.95cm) and Borders 3 and 4 as shown in Diagram AA. Sew in the order shown from the center out. Pin RST matching center and ends, sew and press. The finished Quilt Top should measure 72 1/2" x 72 1/2" / 184.15cm x 184.15cm.

Dia. AA

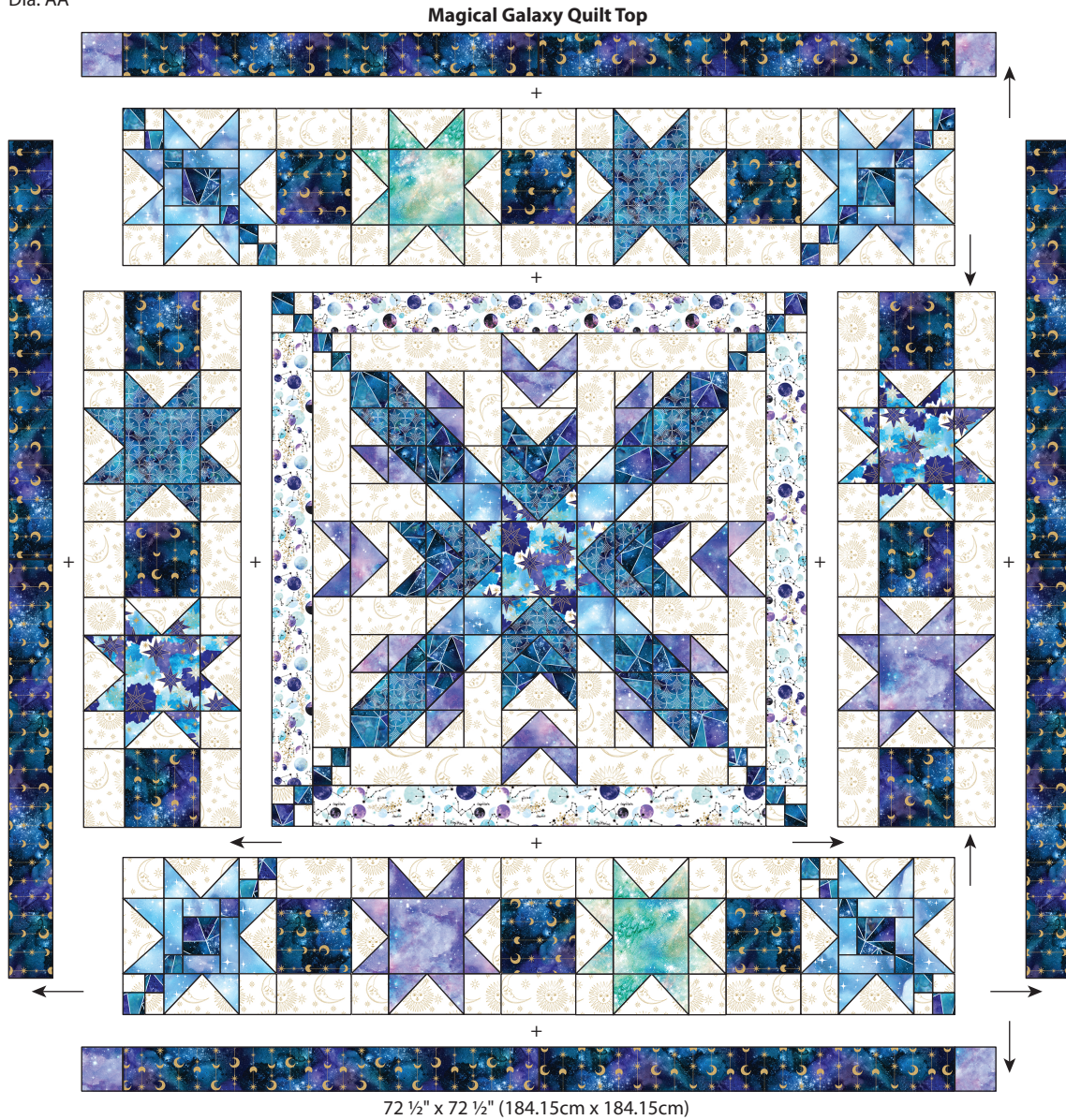

Finishing

24. Remove the selvages from the Celestial Charts Backing. Cut one piece $40\frac{1}{2}" \times 80"$ / $102.87\text{cm} \times 203.2\text{cm}$ and two pieces $20\frac{1}{4}" \times 80"$ / $51.44\text{cm} \times 203.2\text{cm}$. Pin RST and sew along the long edges as shown in Diagram BB. Press seams open or to one side. The Backing should measure $80" \times 80"$ / $203.2\text{cm} \times 203.2\text{cm}$.

Dia. BB

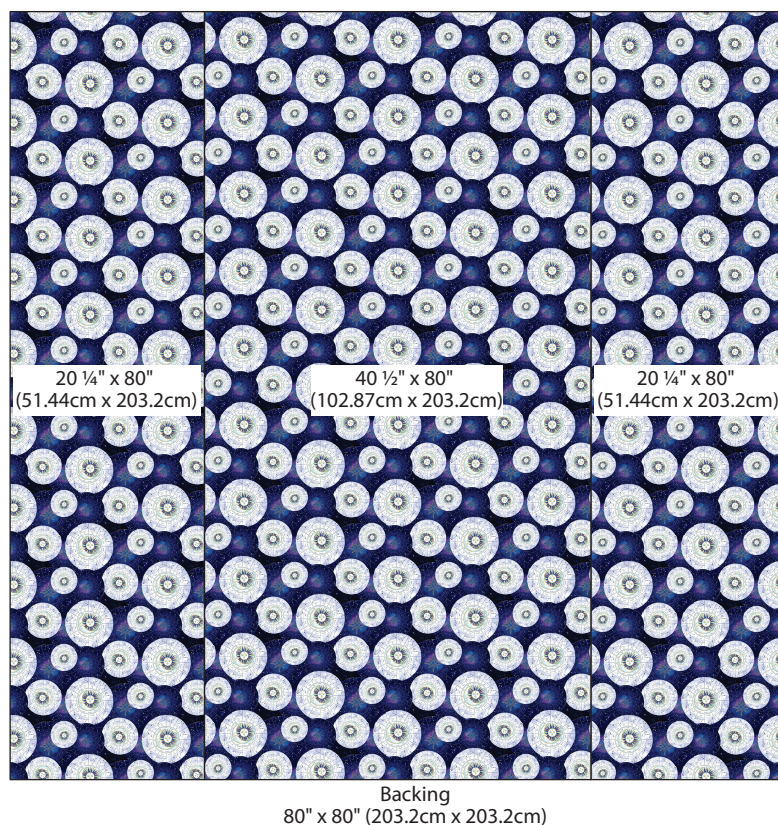

25. Press finished Quilt Top and Backing. Tape the Backing, **wrong** side up, to a firm surface. Layer Batting and Quilt Top (right side up). Baste the layers together with safety pins. Quilt as desired.

26. Once quilting is complete, square up corners and edges, trimming excess Backing and Batting even with the Quilt Top.

27. **Binding** – Follow Diagram CC to make the Stars Binding. Remove selvages and sew the short ends of the eight $2\frac{1}{2}"$ (6.35cm) x wof strips RST end to end at a 45° angle to make one continuous strip; press seams open. Press one short end $\frac{1}{4}"$ (6.35mm) to the **wrong** side. Fold in half lengthwise with **wrong** sides together; press. Leaving a $2"$ (5.08cm) tail on the folded end, place cut edges of folded Binding even with the edge of the Quilt Top and sew, mitering the corners. Overlap ends, trim any excess and finish sewing the Binding. Fold Binding over to back and hand stitch.

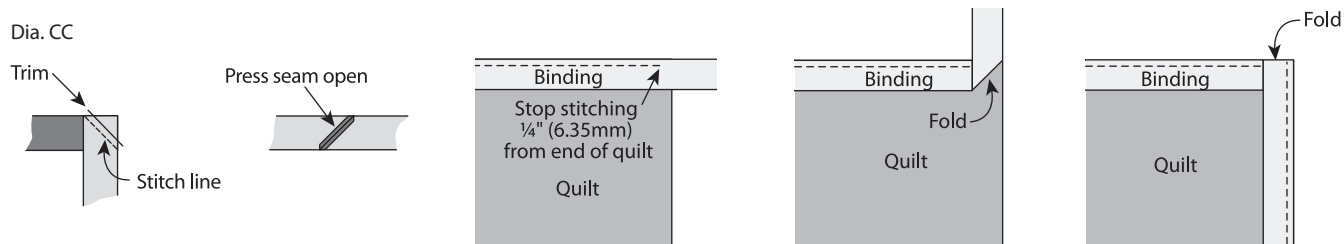

Finished Care Instructions

Machine wash in cold water; gentle cycle. Do not bleach. **Tip:** Before drying, check for fabric dyes that may have run. If fabric dyes run, rewash and rinse using a color catcher to absorb loose dye. Lay flat to dry or tumble dry low.