

**TIMELESS
TREASURES**

BROOME STREET PATTERNS

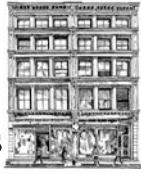

A Very Merry Christmas

Frosted Windowpanes
Designed by Nan Baker



Finished quilt size: 53" x 70"

Fabric Requirements

1 yard Holiday-CM6964 Snow
1¹/₄ yards Holiday-CM6102 Cream
1¹/₄ yard Holiday-CM5166 Natural
1/2 yard Holiday-CM6961 Holly
1¹/₄ yards Holiday-CM5168 Green
(includes 1/2 yard for binding)
1/3 yard Hatch-CM2959 White
2 panels (2/3 yard each) Panel-CM6958 Sage
3²/₃ yards Holiday backing fabric of your choice
61" x 78" batting

Cutting

For easier assembly, label the fabrics as you cut them A-R (There is no I fabric.). Note that the blocks are set on point, so make sure any directional print is cut so the design will be going in the right direction on the finished quilt.

From Holiday-CM6964 Snow:

- Cut seventeen 2" x width-of-fabric (WOF) strips. Sub-cut twenty 2" x 12⁷/₈" strips (**A**), twenty 2" x 11³/₈" strips (**B**) and eight 2" x 13¹/₄" strips (**C**).

From Holiday-CM6102 Cream:

- Cut four 11³/₈" squares on point. Cut once diagonally to make eight triangles (**D**).
- Cut three 10" squares. Cut once diagonally to make six triangles (**E**).

From Holiday-CM5166 Natural:

- Cut two 12¹/₂" squares (**F**).
- Cut three 11³/₈" squares. Cut once diagonally to make six triangles (**G**).
- Cut two 10" squares. Cut once diagonally to make four triangles (**H**).

From Holiday-CM6961 Holly:

- Cut one 11³/₄" square. Cut twice diagonally to make four triangles (**J**).
- Cut two 10" squares. Cut twice diagonally to make eight triangles (**K**).

From Holiday-CM5168 Green:

- Cut fifteen 1¹/₂" x WOF strips. From eight strips, sub-cut fourteen 1¹/₂" x 18¹/₈" strips (**L**) and four 1¹/₂" x 9³/₈" strips (**M**). Save the remaining seven strips for the border.
- Cut seven 2¹/₄" x WOF strips for the binding.

From Hatch-CM2959 White:

- Cut four squares 10" squares. Cut once diagonally to make eight triangles (**N**).

From Panel-CM6958 Sage:

- Referring to the quilt photo for tree positioning, from one panel cut a 12¹/₂" tree top square on point (**O**), centering it along the middle line on the star. Be sure to allow seam allowance above the star to maintain its entirety after seaming. From the second panel, cut a 12¹/₂" tree bottom square on point (**P**), aligning centers. Save the remainder of both panels for later cutting of the tree sides.



Panel Cutting Layout



Imagination... Passion... Creativity

Block Construction

All seam allowances are $\frac{1}{4}$ " and pieces are sewn right sides together.

1. Stitch a 2" x $11\frac{3}{8}$ " CM6964 Snow strip (**B**) to the top of a CM2959 White (**N**) triangle (figure 1). Add a CM6964 Snow 2" x $12\frac{7}{8}$ " strip (**A**) to the adjacent side of the triangle (figure 2). Trim the diagonal edge to make a triangle unit (figure 3). Make a total of eight units.

Fig. 1

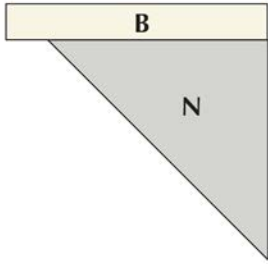

Fig. 2

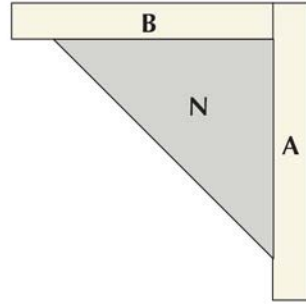
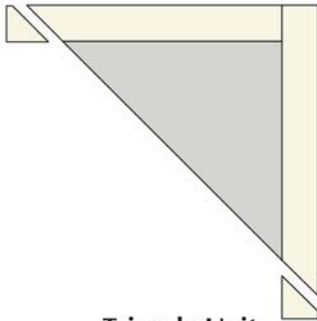

Fig. 3



Triangle Unit
Make 8.

2. Right sides together, center and stitch a CM6102 Cream triangle (**D**) to a $1\frac{1}{2}$ " x $18\frac{1}{8}$ " CM5168 Green strip (**L**) (figure 4).

Tip: Fold the triangle in half and finger-press to make a center crease. Do the same with the green strip. Match the centers and stitch together.

Stitch this unit to the bottom of the step 1 unit. Trim the block to $12\frac{1}{2}$ " square (figure 5).

Fig. 4

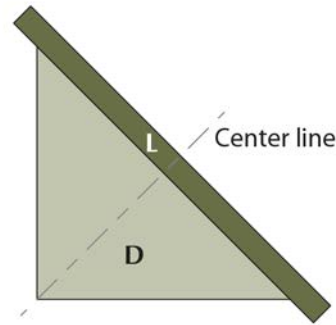
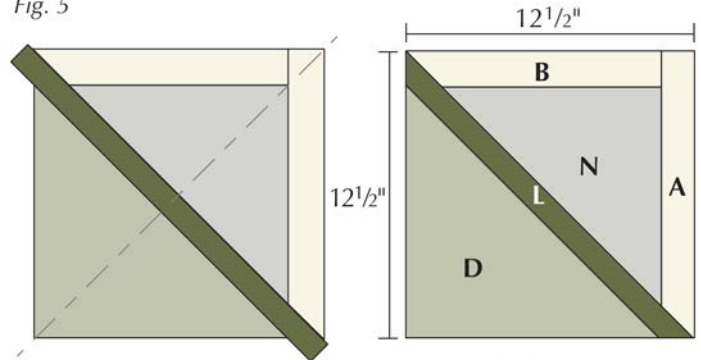

Fig. 5



Make 8.

3. Following steps 1 and 2, make four blocks using the CM6964 Snow (**B**) and (**A**) strips, the $1\frac{1}{2}$ " x $18\frac{1}{2}$ " CM5168 Green strip (**L**) and the CM5166 Natural (**G**) and (**H**) triangles (figure 6). The blocks should measure $12\frac{1}{2}$ " square.

Fig. 6

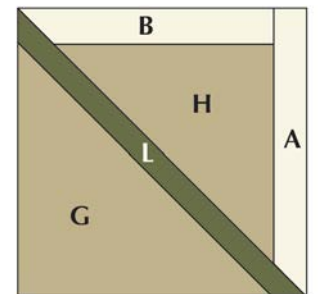

Make 4.

4. To make the corner, top and bottom blocks, sew a 2" x 13¹/₄" CM6964 Snow strip (C) to the bottom of a CM6961 Holly triangle (K). Make a total of eight blocks (figure 7). Trim the block sides at an angle.

Fig. 7

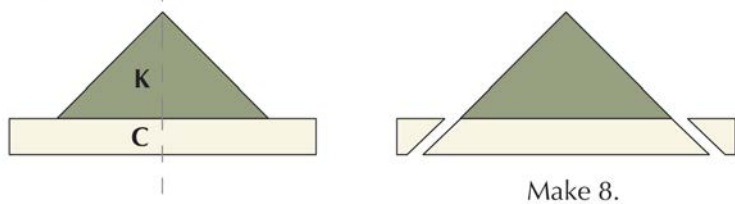

5. For the top left middle holly block and the bottom right middle block, use a unit made in step 4, then add a 1¹/₂" x 9³/₈" CM5168 Green strip (M) to the left side of the triangle, aligning the upper edge. Trim the ends (figure 8). Add a CM6961 Holly triangle (J) to the (M) strip; trim (figure 9). Make two. In the same manner, mirror these directions to make the top right middle holly block and the bottom left middle holly block (figure 10).

Fig. 8

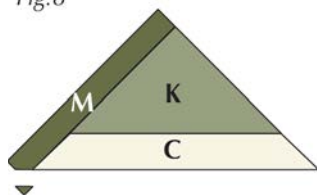
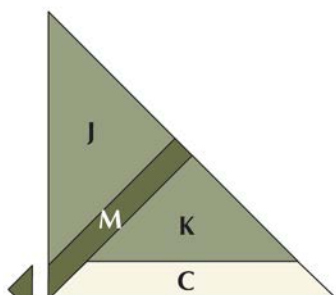
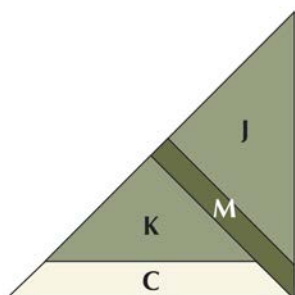

Fig. 9



Make 2.

Fig. 10



Make 2.

6. Stitch a 2" x 11³/₈" CM6964 Snow strip (B) to the top of a CM6102 Cream triangle (E) (figure 11). Add a 2" x 12⁷/₈" CM6964 Snow strip (A) to the adjacent side of the triangle (figure 12). Trim the edges to make a triangle unit (figure 13). Make a total of six units for the quilt sides.

Fig. 11

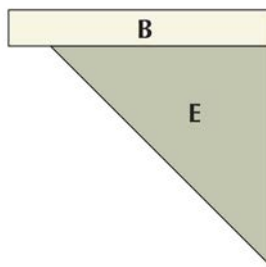

Fig. 12

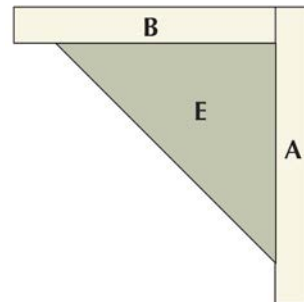
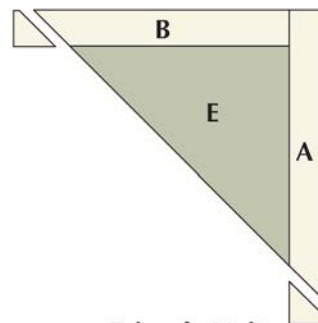

Fig. 13



Triangle Unit
Make 6.

Quilt Top Assembly

7. Following the Quilt Assembly Diagram, lay out the quilt top in diagonal rows. Using the remaining portions of the tree panels, align the right edge of the branches and cut a 10" square on point (Q). Then align the left edge of the branches and cut a 10" square on point (R). Note that the entire 10" square may not fit on the panel, but only the tree portion is used for the final block image. For easier alignment, mark the actual tree edges on the square template and cut from either of the panel leftovers, depending on the image placement and fit. Cut each square in half diagonally as it will be oriented in the quilt, noting that the blocks are mirrored.



- Referring to step 3, make the mirrored side tree blocks using the CM5166 Natural (**G**) triangles, CM6964 Snow (**A**) and (**B**) strips, a $1\frac{1}{2}$ " x $18\frac{1}{8}$ " CM5168 Green strip (**L**), along with the fussy-cut (**Q**) and (**R**) triangles (figure 14).

Fig. 14

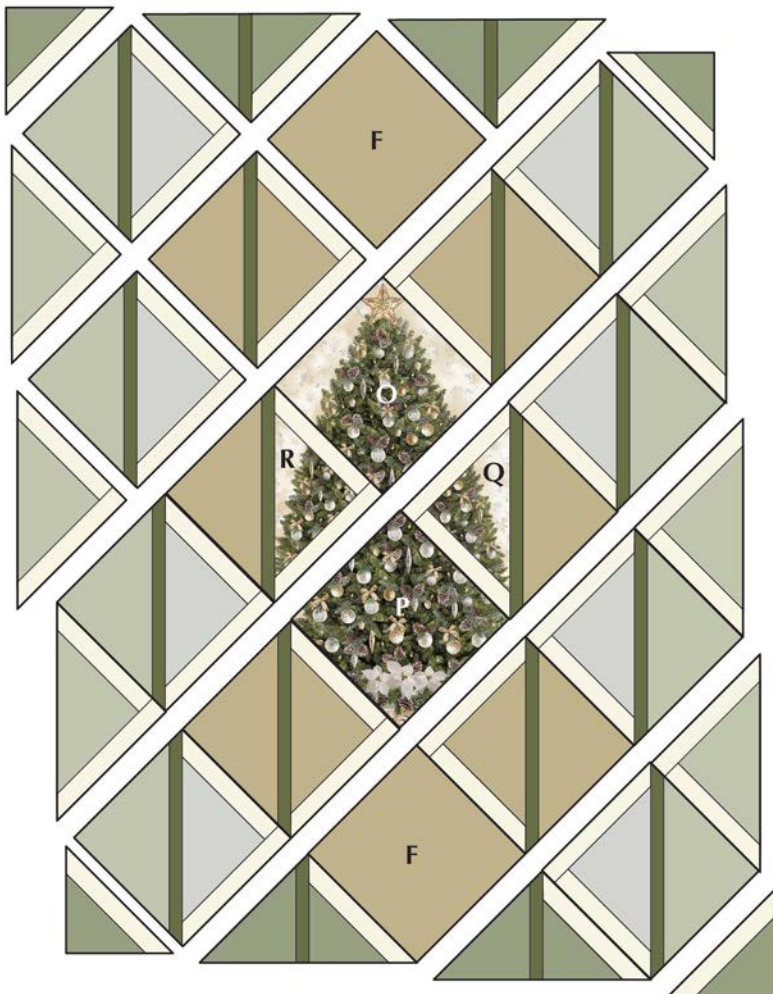
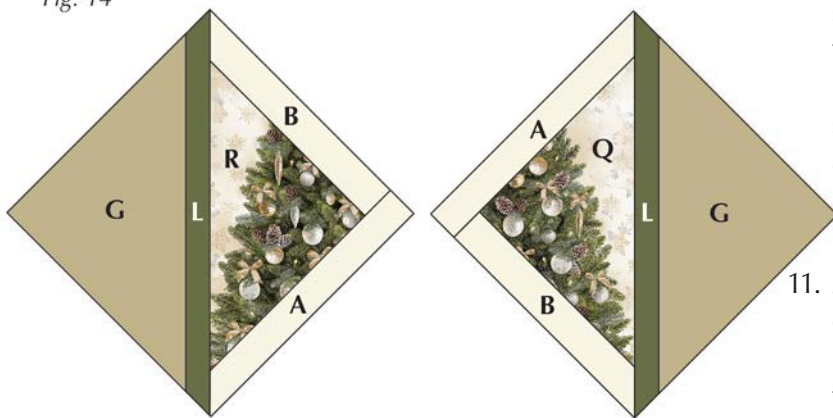

Quilt Assembly Diagram

- Begin sewing the rows together with the top left corner block and work downward toward the bottom right corner block, matching adjacent seams.
- For the border, sew the $1\frac{1}{2}$ " x WOF CM5168 Green border strips together end to end using diagonal seams. Measure the width of the quilt top through the center and cut two strips that length from the pieced strip. Sew one strip to the top and the other strip to the bottom of the quilt top. Press seam allowances toward the border.
- Measure the length of the quilt top through the center. Cut two strips that length from the remaining pieced border strip. Sew one strip to each side of the quilt top. Press the seam allowances toward the border.

Finishing

- Layer the quilt top, batting and backing, and quilt as desired.
- Stitch the binding strips together end to end using diagonal seams. Fold and press the resulting long strip in half lengthwise with wrong sides together. Stitch to the quilt front, matching raw edges and mitering the corners.
- Fold the binding to the quilt underside and hand-stitch the folded edge to the quilt back.

Nan Baker
www.purrfectspots.com

©2019 Timeless Treasures www.ttfabrics.com
This pattern is for individual home use only. This pattern may not be reproduced for commercial purposes (i.e., may not be sold).