

# All A Buzz Pillow

Designed by LJ Simon  
Featuring the Twilight by Bee My Sunshine Collection  
Size: 16" x 16"









FREE  
PROJECT



**PLEASE NOTE:** BEFORE MAKING YOUR PROJECT, CHECK FOR ANY PATTERN UPDATES AT [WINDHAMFABRICS.COM](http://WINDHAMFABRICS.COM)'S FREE PROJECTS SECTION.



# All A Buzz Pillow

FABRIC	SKU NUMBER	YARDAGE
	43318-3 Cream	FQ
	43315-1 Grey	1/8 or F1/8
	43319-1 Grey	1/8 or F1/8
	43317-4 Green	1/8 or F1/8
	43315-4 Green	1/8 or F1/8
	43318-6 Orange	1/8 or F1/8
	43319-6 Orange	1/8 or F1/8
	43314-2 Sunshine	1/8 or F1/8
	43316-5 Yellow	1/2

### Additional Requirements:

- 1/2 yards light weight woven fusible
- (1) 16" square pillow form for insert
- Aurifil embroidery floss - see last page for details

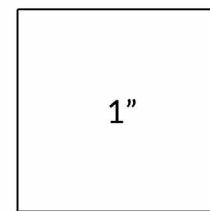

Test Template size to be sure it is correct

### Special Notes:

**\*\* All seam allowances are 1/4" wide**  
 Make sure you take your time to cut and sew carefully. With all items that have lots of piecing, your project can very easily become too small / large and you will have trouble later attaching pieces to make the correct size.

### Cutting:

- 43318-3 Cream Honeycomb
- Cut (1) 1 1/2" x 12 1/2" strip for top section
  - Cut (2) 2 1/2" x 5" rectangles for each side of piece A
  - Cut (2) triangle templates labeled 1 & 2 at right for A
  - Cut (2) 2 1/2" x 4 1/2" rectangles for each side of piece B
  - Cut (2) 2 1/2" x 4" rectangles for each side of piece C
  - Cut (2) 2 1/2" x 3 1/2" rectangles for each side of piece D
  - Cut (2) 1 1/2" x 3" rectangles for each side of piece E
  - Cut (2) 1 1/2" x 3 1/2" rectangles for each side of pieces F
  - Cut (1) 1 1/2" x 4 1/2" rectangle for inside of pieces F
  - Cut (6) 1" x 1" squares for beehive corners

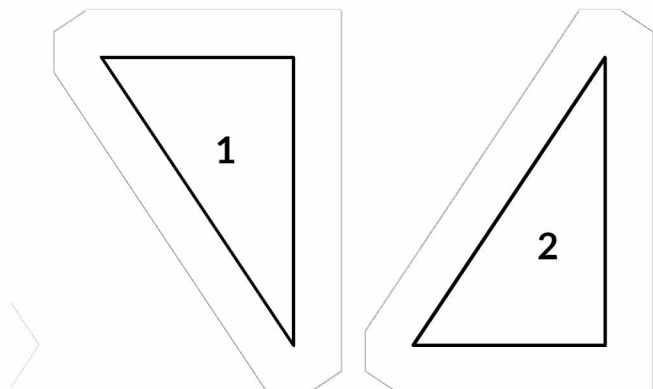



# All A Buzz Pillow

### 43315-1 Grey Sunflowers

Cut (2) 2" x width of fabric (WOF) strips. Subcut into:  
(4) 2" x 13 1/2" strips for outer borders

### 43319-1 Grey Stripe

Cut (2) 1" x WOF strips. Subcut into:  
(2) 1" x 12 1/2" rectangles for inner border sides  
(2) 1" x 13 1/2" rectangles for inner border top & bottom

### 43317-4 Green Bees

Cut (1) 1 1/2" x 12 1/2" strip for bottom

### 43315-4 Green Sunflowers

Cut (1) 1 1/2" x 7 1/2" rectangle E for beehive stand  
Cut (2) 1 1/2" x 1 1/2" squares F for beehive stand legs

### 43318-6 Orange Honeycomb

Cut (1) 2 1/2" x 6 1/2" rectangle D  
Cut (4) 2" x 2" squares for cornerstones

### 43319-6 Orange Stripe

Cut (1) 2 1/2" x 4 1/2" rectangle B

### 43314-2 Sunshine Collage Print

Cut (1) using template A at right - fussy cut desired flower

### 43316-5 Yellow Words - Note: direction of the words are parallel to the selvage

Cut (1) 5 1/2" x 2 1/2" rectangle C  
Cut (1) 11" x 16 1/2" for pillow back top piece  
Cut (1) 10" x 16 1/2" for pillow back under piece

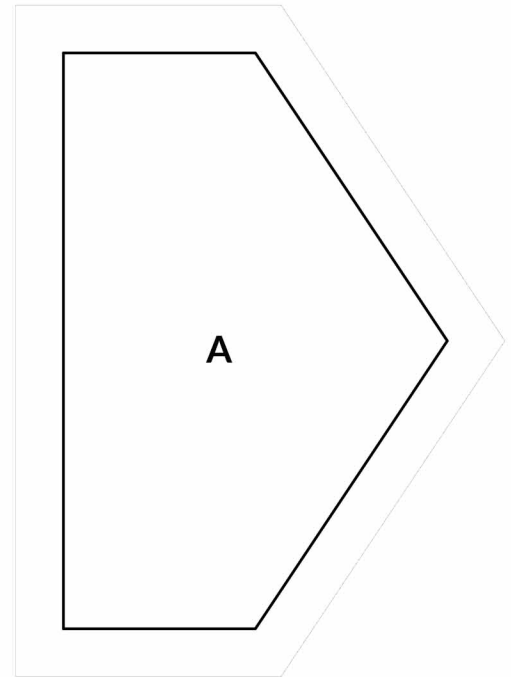

TEMPLATE A

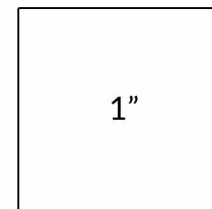

Test Template size to be sure it is correct

## Assembly:

1. With right sides together, sew the template pieces 1 & 2 to the top of template A. Starting with the left side, press and then the right side. Press. Sew (2) cream beehive 2 1/2" x 5" rectangles to each side.

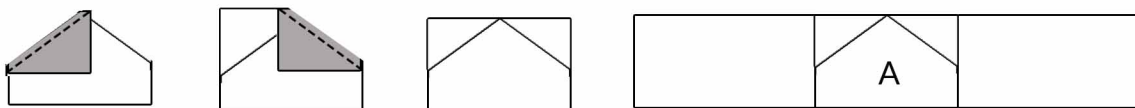

2. Draw a diagonal line on the wrong side of (1) 1" x 1" cream honeycomb square. Place square, right sides together, at a corner of (1) 2 1/2" x 4 1/2" B rectangle. Sew on drawn line. Trim 1/4" away from sewn line. Open and press to reveal corner triangle. Repeat with another 1" x 1" square at the opposite corner of the same B rectangle. Add (2) cream beehive 2 1/2" x 4 1/2" rectangles to each side.

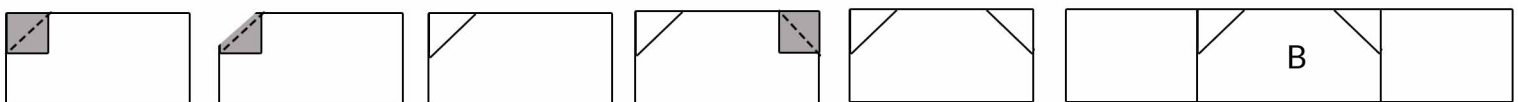

3. Repeat the same steps for C & D as you did in Step 2 above. Add the cream beehive rectangles on each side by matching the size from the cutting instructions: 2 1/2" x 4" for C and 2 1/2" x 3 1/2" for D.



# All A Buzz Pillow

4. Take rectangle E and with right sides together, sew the 1 1/2" x 3" cream honeycomb rectangles to each end of the rectangle.



5. Take one square F and with right sides together, sew a 1 1/2" x 3 1/2" cream honeycomb rectangle to the left side. Take the 1 1/2" x 4 1/2" rectangle and sew that to the right side. Take the second square F and sew it with right sides together to the right side of the 1 1/2" x 4 1/2" rectangle. Finally sew with the right sides together, sew the last 1 1/2" x 3 1/2" rectangle to the right side.



6. To assemble the center beehive, follow the diagram. With right sides together starting with the top and going down to the bottom, sew each section together. Make sure you line up the bottom of the piece on top to the corners of each section below for A-D. Press the seam allowance all in the same direction. The size should finish 12 1/2" x 12 1/2".

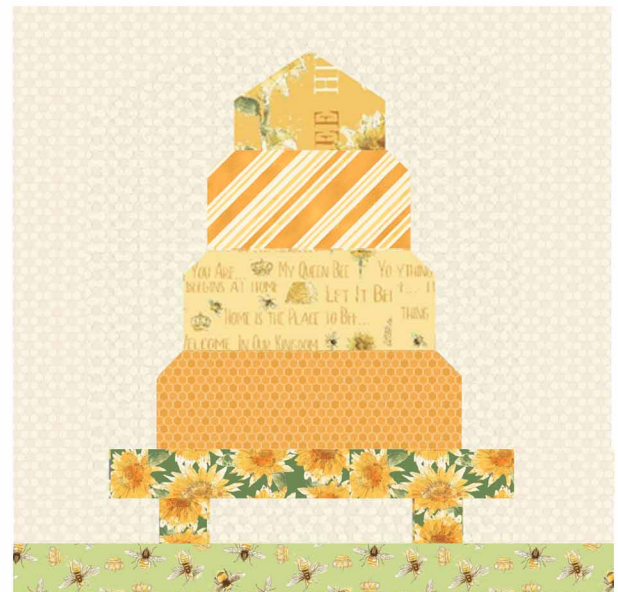
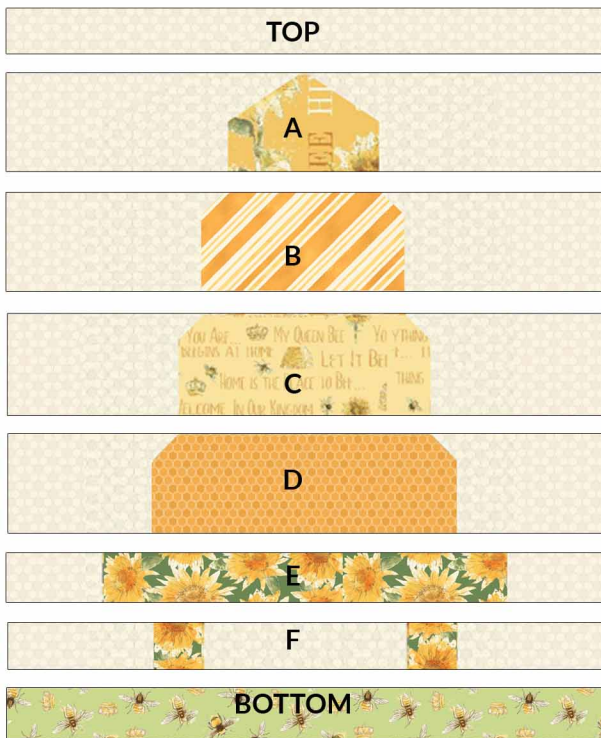

7. Take the inner border 43319-1 grey stripes and with right sides together, add a strip to each side of the center beehive. Press seam allowance toward the outside. Add the top and bottom and press seam allowance toward the outside. The size should measure 13 1/2" x 13 1/2".



# All A Buzz Pillow

- With the right sides together, take the outer border 43315-1 grey sunflower strips and sew to each side. Press seam allowance to the outside.
- With right sides together, take cornerstone squares 43318-6 orange honeycomb and sew to each end of the top outer border and the bottom outer border. With right sides together, sew those to the top and bottom respectively as shown in the diagram. The final size should measure 16 1/2" x 16 1/2".

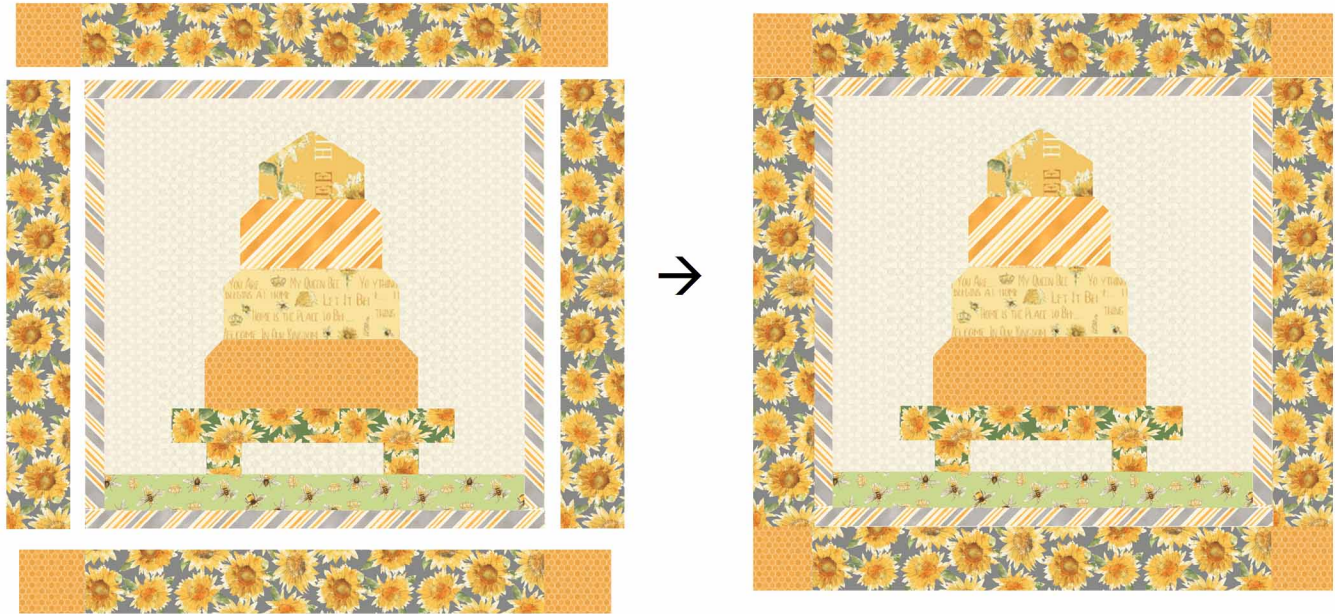

- The face of the pillow is now completed. At this point add the embroidery following the embroidery template on last page. Once the embroidery is complete, add the light weight woven fusible to the wrong side of the pillow face following the manufacturer's recommended instructions. This will help even out the color so the seam allowances will not be so evident on the face. It will also cover all raw edges and keep the inside of the pillow shell clean.

## Back

- Take 16 1/2" x 11" rectangle of the backing and on one long side, fold fabric toward the wrong side 1/4" and press flat. Fold an additional 1" and press flat. Edge stitch open edge.
- Take 16 1/2" x 10" rectangle and on one long side, fold fabric toward the wrong side 1/4" and press flat. Fold an additional 1/4" and press flat. Edge stitch open edge.
- With right sides facing down, overlap the small under piece on top of the larger top piece so that the final length is 16 1/2". Pin the sides together to hold in place. The overlap is approximately 3".
- Add an edge stitch on each end to hold the overlapped sections in place.

## Finishing

- With right sides together, place face on back and sew around the outside of the pillow shell on all 4 sides. Clip corner seam allowance and cover stitch seam allowance edges or add a tight zigzag stitch to prevent raveling. Turn and press.
- Add a 16" pillow form to complete your pillow.

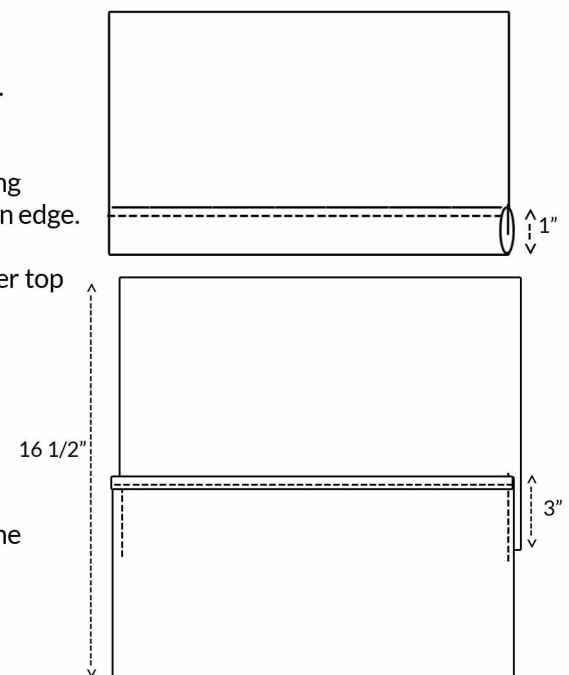



# All A Buzz Pillow

Page 6

## EMBROIDERY TEMPLATE

We used Aurifil embroidery floss for this project:

Black # 2692

Gold # 2135

To create the same delicacy, 2 strands of floss were used

Outline of bee, antennae and wings - backstitch

The bee flying trails - running stitch

Body and head - satin stitch

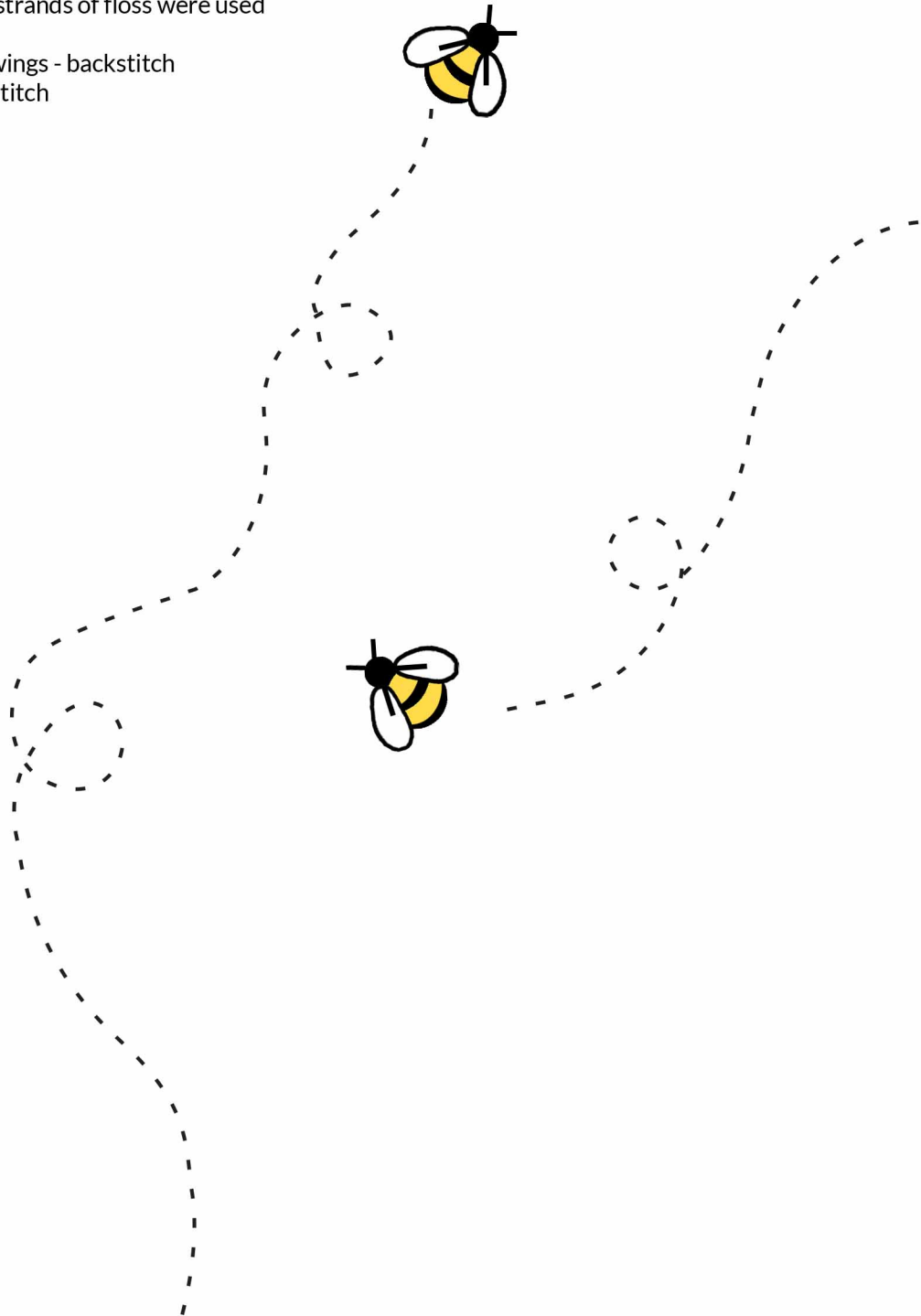

*A special thanks to Wendy Sheppard for her inspiration for the pillow that was based on her **All A Buzz Quilt** she designed for this collection. Go the [www.windhamfabrics.com](http://www.windhamfabrics.com) to see this and other Bee My Sunshine free projects. Wendy's skillful hands also created the embroidery design for this pillow.*