

Punch Studio



SEASCAPE

Quilt design by Linda Fitch featuring fabrics from the "Seascape" collection
by Punch Studio for Hoffman California Fabrics

Sand Colorway



Quilt Size 57" x 68"

Free pattern available from www.hoffmanfabrics.com



L7310
62G-Sand/Gold



L7311
73G-Ocean/Gold



L7312
62G-Sand/Gold



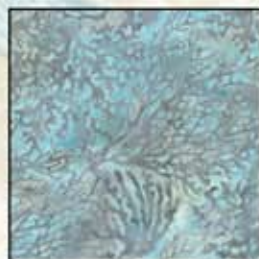
L7313
536G-Aquarius/Gold



L7314
536G-Aquarius/Gold



L7314
62G-Sand/Gold



L2643
450-Spa



L2643
A25-Antique Beige

More about

Punch Studio



Chances are you've purchased a lovely note pad, an elegant vase, or a stylish home accessory featuring finely decorative artwork by Punch Studio and not realized it. This brand can be found at booksellers, boutiques, home-decor stores and gift shops.

The Punch Studio look is much in demand for its sophisticated and detailed artwork that is timeless and invites repeat viewing. See more by this stationery designer at www.punchstudio.com.

HOFFMAN FABRICS

CALIFORNIA-INTERNATIONAL

“Seascape” featuring fabrics by Punch Studio for Hoffman California Fabrics

Yardage Chart

Fabric cutting	Sand Colorway	Pacific Colorway	
#1	L7310 62G-Sand/Gold	L7310 133S-Pacific/Silver	3/8 yard
#2	L7311 73G-Ocean/Gold*	L7311 19S-Navy/Silver*	2 1/4 yards
#6	L7312 62G-Sand/Gold	L7312 133S-Pacific/Silver	7/8 yard
#3	L7313 536G-Aquarius/Gold	L7313 133S-Pacific/Silver	5/8 yard
#4	L7314 62G-Sand/Gold	1895 367-Aspen	1/4 yard
#5	L7314 536G-Aquarius/Gold	L7314 133S-Pacific/Silver	1/2 yard
#8	L2643 A25-Antique Beige	L2621 472-Pebble	1 yard
#7	L2643 450-Spa	L2643 230-Sapphire	1 1/8 yard

*Yardage includes binding.

BACKING: Coordinate of your choice. 4 3/8 yards

Pacific Colorway



L7310
133S-Pacific/Silver



L7311
19S-Navy/Silver



L7312
133S-Pacific/Silver



L7313
133S-Pacific/Silver



L7314
133S-Pacific/Silver



1895
367-Aspen



L2621
472-Pebble



L2643
230-Sapphire

SEASCAPES

Quilt design by Linda Finch

featuring the *Seascape by Punch Studio* collection produced by Hoffman California Fabrics

Finished quilt size = 54" x 65½"

Skill level: Intermediate/Experienced

Extra supplies needed: freezer paper, a fabric glue stick and liquid fabric glue, such as Roxanne's.

Please read all instructions first. Organize and identify the cut pieces in stacks.

All seam allowances are ¼".

WOF = width of fabric. LOF = length of fabric. HST = Half Square Triangles

Cutting Instructions

All strips are cut the WOF unless stated otherwise.

Fabric 1- Cut (3) 9 ½ " squares

Fabric 2- Cut (6) 2 ¼ " strips for binding.

Cut (2) 3 ½ " strips LOF, for the right and left sides of the outside border.

From the balance of the width, cut (4) 3 ½ " strips WOF, for top and bottom outer borders.

Sew together at short ends. Put aside for now.

For starfish...using templates B, E, H, K & N, cut 5 pieces each. Make sure fabric is layered with right sides up. Align the longest side of the template to the grain of the fabric.

Put aside the remaining fabric for now, it will be used to cut 21 Dresden petals later.

Fabric 3- Cut 2 strips at 9 ½ ". Sub-cut into (5) 9 ½ " squares and (4) 2 ½ " squares. You may wish to fussy cut and center a motif, in the small squares.

Fabric 4- Cut 2 strips at 2 ½ ". Sub-cut into (30) 2 ½ " squares.

Fabric 5- For inner borders, cut (5) 2 ½ " strips WOF.

Fabric 6- Cut 2 strips at $9\frac{1}{2}$ ". Sub-cut into (7) $9\frac{1}{2}$ " squares, for background to shell blocks. From leftover, using templates A, D, G, J & M, cut 5 pieces each. This will be the background for the starfish blocks. Always align the longest edge of template to the straight of the grain.

Fabric 7- Cut (1) 3" strip. Sub-cut (7) 3" squares.

For starfish, using templates C, F, I, L & O, cut 5 pieces each. Make sure the fabric is layered with the right sides up. Align the longest side of the template to the straight of the grain.

Put aside the remaining fabric for now. It will be used to cut 14 Dresden petals later.

Fabric 8- Cut (1) 3" strip. Sub-cut into (7) 3" squares.

Cut 3 strips at $2\frac{1}{2}$ ". Sub-cut (14) $2\frac{1}{2}$ " x $7\frac{1}{2}$ " rectangles.

Cut 9 strips at $2\frac{1}{2}$ ". Sub-cut (35) $2\frac{1}{2}$ " x $9\frac{1}{2}$ " rectangles.

Starfish Block

Basically, the 5 starfish blocks are all the same. It is when they are rotated at different degrees that they take on a different appearance. All points are not symmetrical, thus all of the slightly different template pieces.

Refer to the diagram at the bottom of Page 1 (of 4) Star Template for piecing the starfish sections.

For Section 1, take an A (ground), B (dark) and C (light) and position as shown. You will be sewing what is commonly referred to as "Y" seams.

Sew B to A. Stop within $\frac{1}{4}$ " of the corner where the 3 pieces meet. Sew C to A. Stop to within $\frac{1}{4}$ " of the corner where the 3 pieces meet. Sew the short seam joining pieces B and C. Repeat 4 more times.

For Section 2, join piece E to D, stopping to within $\frac{1}{4}$ " of the corner where the 3 pieces will ultimately meet. Sew piece F to D, stopping to within $\frac{1}{4}$ " of the same corner. Sew the short seam, joining pieces E and F. Repeat 4 more times.

Continue the same with the remaining 3 sections.

Sew the sections together, working clockwise. Sew Section 1 to Section 2. Section 3 to Section 2. Section 4 to Section 3 and so on. Complete the block by joining Section 5 to Section 1. Press all the seams in one direction.

Dresden Plate Block *Applique Technique*

Trace 35 Dresden petals onto the paper side of the freezer paper. Trace on the solid/finish line and not the dotted line.

Cut the paper along the solid/finish line, cutting away the ¼" seam allowance (paper only).

Using the fabric glue stick, apply glue to the paper (non wax) side and lay onto the wrong side of the corresponding fabric, wax side up. Finger press. Cut ¼" beyond the paper 21 petal shapes from Fabric 2 and 14 petals from Fabric 7.

Fold over the ¼" of fabric and press with a hot dry iron. Construction tip: to save time and reduce bulk, we overlapped the pieces leaving the very outside edges unfolded. For example...Fabric 7 (light), we only pressed under the top curve of the petal, to the notches on the pattern piece. The remaining seam allowance will be covered with Fabric 2.

For Fabric 2, we left the side of the petal that would be included in the seam allowance (that attaches this block to the sashing) flat/unpressed. In other words, for these outside petals, press from what will be the outermost notch, along the curved top and down along the whole inner edge of the petal.

At the points with excess fabric, dab a bit of glue stick under the loose fabric and using a pointed tool (like a seam ripper) fold the extra fabric down and press with a hot iron. You do not need to be so concerned with the points of the light fabrics, because they will be covered by the dark. All raw edges within the block will be covered with A, C, & E petals.

Practice the positioning of the petals before adhering to the background piece (Fabric 6 9 ½" squares). Refer to the photo for guidance.

Once you are comfortable start with the light (Fabric 7), take the liquid fabric glue and lightly dot on all edges, turned and unturned. Position on the background and hand press. **Do not use an iron.**

Now dot the dark (Fabric 2) along all turned and unturned edges and place, overlapping the raw seam allowances of the light fabrics and matching the outside edge of the background piece.

Using a mono-filament thread, sew a very small open zig-zag along the folded edges to hold in place.

Besides creating your shapes, the paper serves as a stabilizer. Your stitches will keep the folded fabric edges smooth. You may wish to baste the outside edges together.

Once you have appliqued the pieces to the background, carefully slit the background fabric only. Cut away the background fabric to within ¼"- ½" of stitching lines. Remove the freezer paper.

Sashing

Take the 3" squares of Fabric 8 and draw a line (on the back side) once diagonally from corner to corner.

Join Fabric 8 squares to the Fabric 7 squares RST and sew $\frac{1}{4}$ " from each side of the drawn line. Cut on the drawn line and you will have 2 half-square triangles that should measure $2\frac{1}{2}$ ". If not, square-up. Repeat 6 times, creating (14) $2\frac{1}{2}$ " HST's.

Attach each HST to the end of a Fabric 8 $2\frac{1}{2}$ " x $7\frac{1}{2}$ " rectangle.

From this point on it is easiest to refer to the photo for correct positioning.

Sew the blocks together (horizontally), 1 row at a time inserting in the appropriate sashing in between. Note that you will be interspersing the $9\frac{1}{2}$ " sashing rectangles, as well as the $7\frac{1}{2}$ " with the HST. Remember to vary the starfish blocks, in varied degrees, for more interest. Keep in mind the position of the sashings with HST's. The whole point of those is to give the appearance of a base at the bottom of the shell.

Sew the horizontal sashing interspersing the $2\frac{1}{2}$ " Fabric 4 squares, the $7\frac{1}{2}$ " with the HST and the $9\frac{1}{2}$ " rectangles where indicated. Sew all the horizontal rows together.

Borders

For inner borders, sew all of the Fabric 5 strips together, at the short ends. Put aside for now.

Fold the quilt in half crosswise. Measure from the fold to the raw edges where the top and bottom edges meet. Double this and cut 2 lengths of this measurement for the side inner borders.

Fold the quilt in half lengthwise. Measure from the fold to the raw edges where the left and right sides meet. Double this and cut 2 lengths of this measurement. Add a Fabric $3\frac{1}{2}$ " square to each end of the 2 strips.

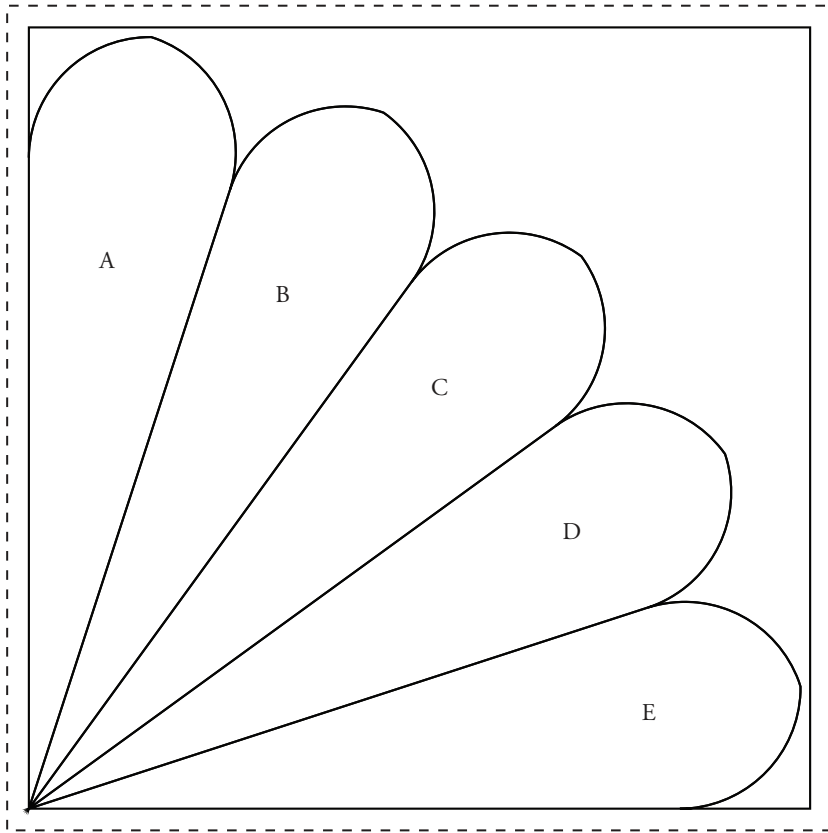
Sew the first 2 strips to the left and right sides of the quilt. Sew the remaining strips, with the squares on each end, to the top and bottom.

For the outer borders, fold the quilt in half crosswise. Measure from the fold to the raw edges where the top and bottom edges meet. Double this amount and cut 2 lengths from the Fabric 2 LOF strips. Attach to the left and right sides.

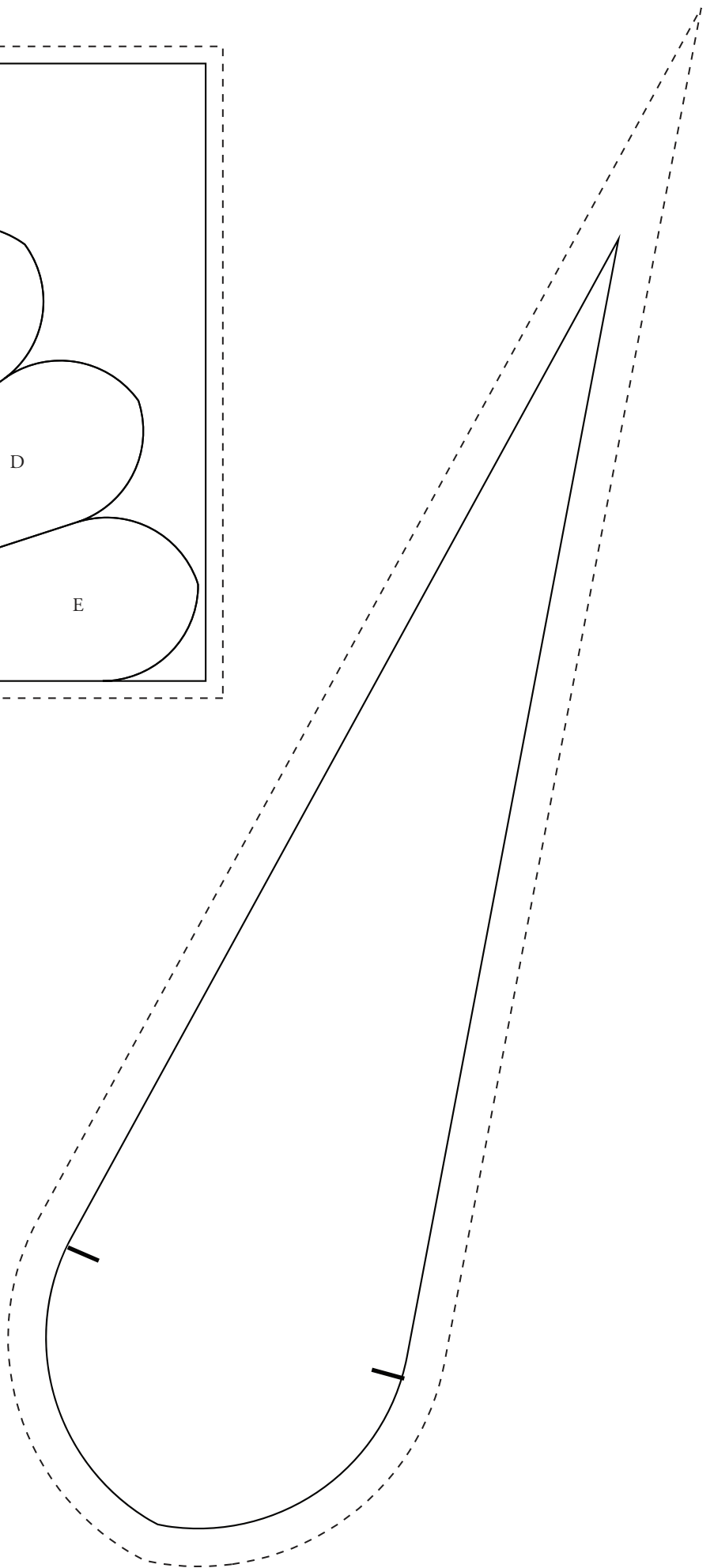
Fold the quilt in half lengthwise and measure from the fold to where the right and left edges meet. Double this amount and cut 2 lengths to this measurement. Attach 1 to the top and the 2nd strip to the bottom.

Layer the backing, batting and top. Quilt and bind using your favorite method.

Dresden Template (pg 1 of 1)

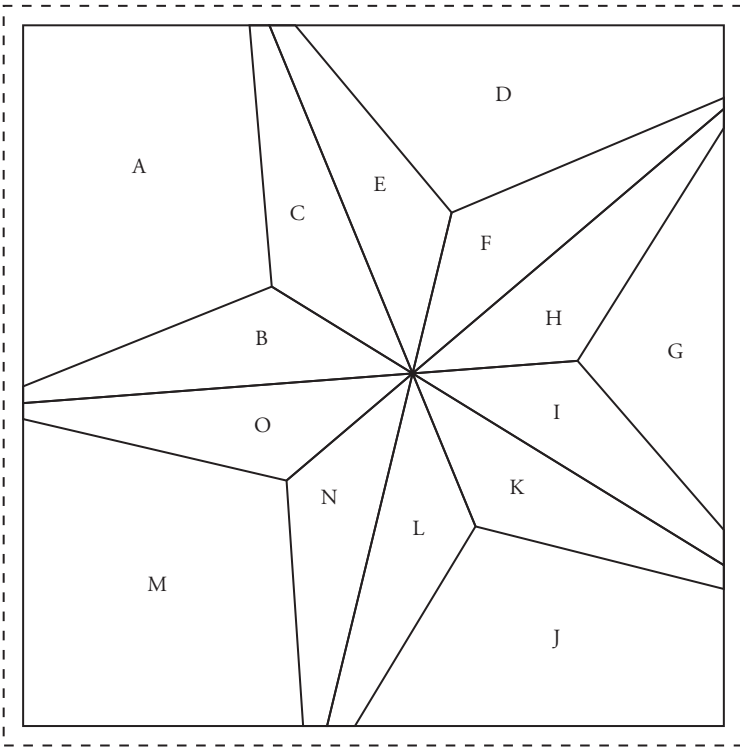


*diagram not to scale

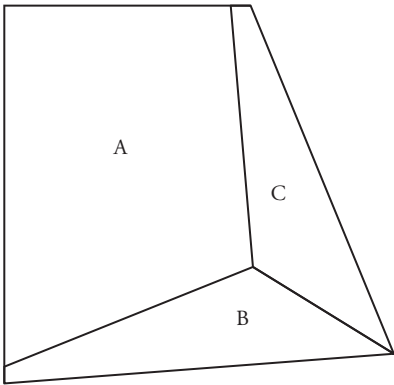


Star Template (pg 1 of 4)

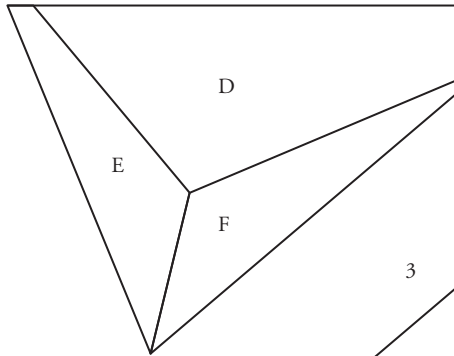
*diagram not to scale



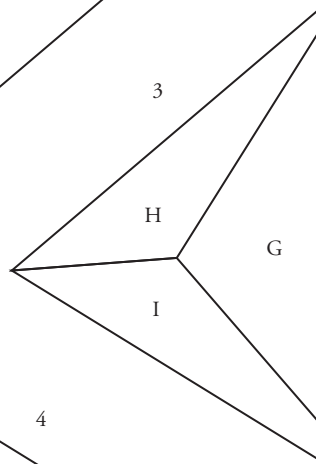
1



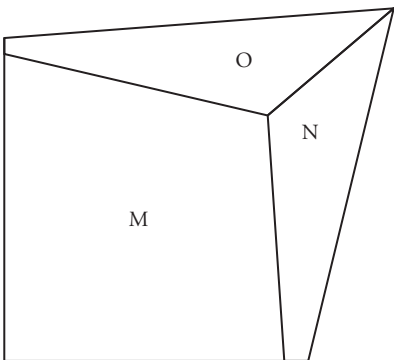
2



3



5



4

