

Morning Star

by Barbara Groves of Me & My Sister Designs

Do you jump out of bed ready to get the day started? Well, I don't, but I still consider myself a morning person. I'm slower to throw off the covers, but if I have something to do and it doesn't get done before noon, it's probably going to get put on the pile for tomorrow! I hope you enjoy sewing this fun block bright and early this morning!

@meandmysisterdesigns

meandmysisterdesigns.com

Cutting Instructions

Qty	6" finished block	12" finished block
4	2" squares (A)	3 1/2" squares (A)
4	1" x 2" rectangles (B)	1 1/2" x 3 1/2" rectangles (B)
4	2 1/2" x 1" rectangles (C)	4 1/2" x 1 1/2" rectangles (C)
1	3 1/2" square (D)	5 1/2" square (D)
4	2 1/8" squares (E)	3 1/8" squares (E)
1	3 1/2" square (F)	5 1/2" square (F)
4	2 1/8" squares (G)	3 1/8" squares (G)
1	2 1/2" square (H)	4 1/2" square (H)

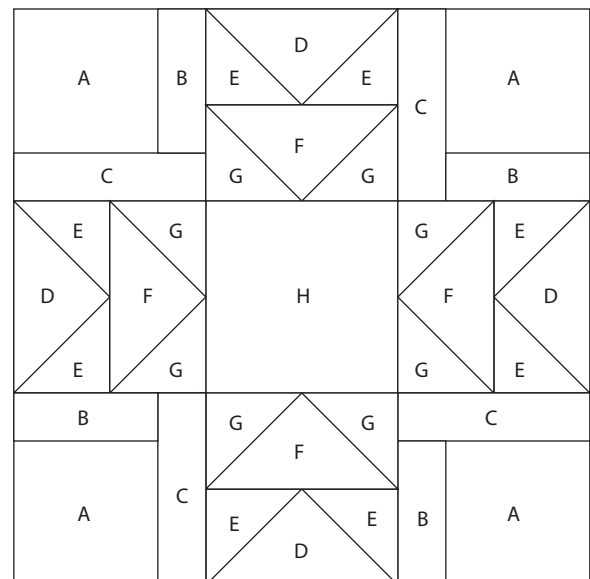

Use this block to plan color and fabric placement!

My Swatches

A B C D E F

G H





Piecing Instructions

Step 1

Sew a B rectangle to one side of an A square as shown. Press towards the B rectangle.

Sew a C rectangle to the bottom of the A/B unit as shown. Press towards the C rectangle.

Repeat to make 4 corner units measuring 2 1/2" (6" block) or 4 1/2" (12" block).

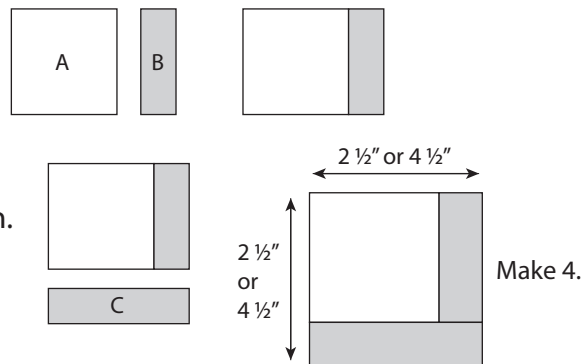

Step 2

On the wrong side of each E square, draw a line from one corner to the opposing corner as shown.

With right sides together, align 2 E squares in opposite corners of the D square as shown.

Stitch a scant 1/4" seam on both sides of the drawn line. Cut the square apart on the line to yield 2 partial flying geese units, and press the seams to the E triangles.

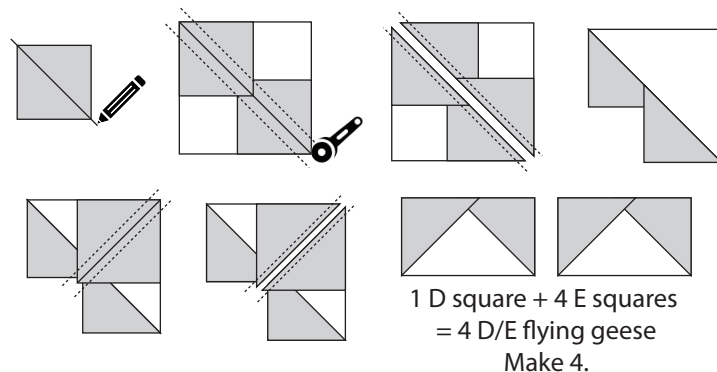

With right sides together, align another E square in the corner of the D triangle as shown.

Stitch a scant 1/4" seam on both sides of the drawn line. Cut the square apart on the line to yield 2 complete flying geese units, and press the seams to the E triangles.

Repeat to make 4 D/E flying geese units. Trim to 1 1/2" x 2 1/2" (6" block) or 2 1/2" x 4 1/2" (12" block).

Step 3

Using the F and G squares, repeat Step 2 make 4 F/G flying geese units.

Trim to 1 1/2" x 2 1/2" (6" block) or 2 1/2" x 4 1/2" (12" block).

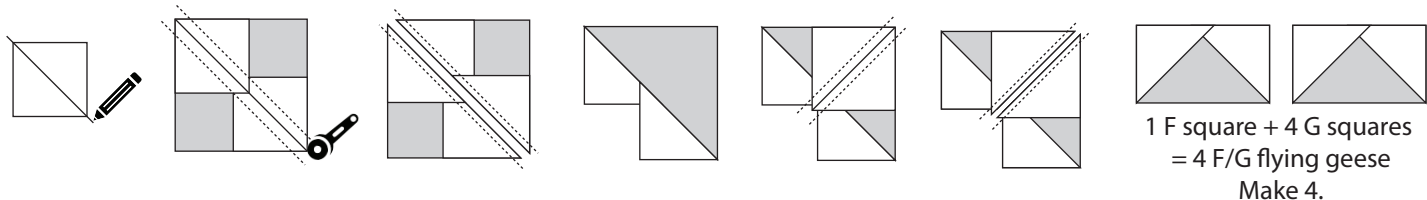

Get to know Barb...

I know the stars have aligned when...
I find forgotten chocolate in my pantry!

I'd be totally star-struck if I could meet...
Donny Osmond.

If I could wish on a star, I'd wish for...
World peace!

Star Trek, Star Wars, or Dancing With the Stars?
Dancing With the Stars.





SCAN ME

Piecing Instructions, continued

Step 4

Lay out 1 D/E flying geese and 1 F/G flying geese as shown. Sew together to make a flying geese unit. Press seam open.

Repeat to make 4 flying geese units measuring
 2 1/2" (6" block) or 4 1/2" (12" block).

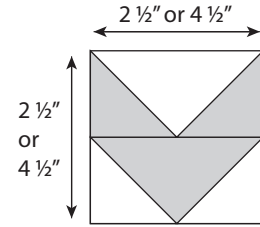
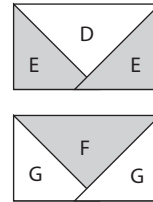

Make 4.

Step 5

Lay out corner units, flying geese units, and H square as shown.

Join units to make the full block. Trim to 6 1/2" or 12 1/2".

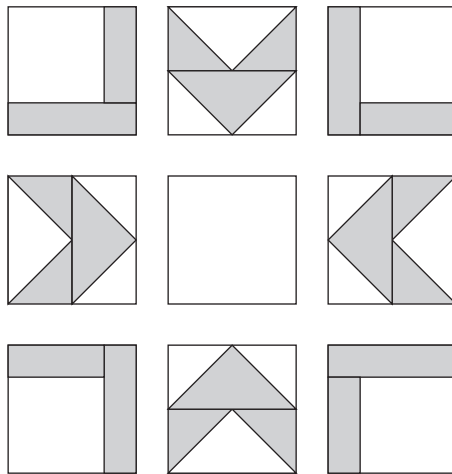



Additional Coloring Blocks

